

BARRISOL[®]

Photos 2



Arch. : Zaha Hadid



Arch. : Ron Arad



Arch. : Jan Kaplicky (Future Systems) et Andrea Morgante (Shiro Studio).



Arch. : Projectatelier



Arch. : Plexgroup



Arch. : Squillace Nicholas Architects



Arch. : Designer Aleksandra Lepka & Lukasz Banaszekiewicz



Arch. : SNC Lavalin & Bodreau Architecture



Arch. : Henn Architekten

2012-2013



Photos 2

2012 - 2013

Bienvenue, welcome, willkommen

Fiers de nos 45 années d'expérience, nous décorons, renovons et embellissons tous types de lieux grâce à des solutions alliant technicité performance et esthétisme.

Parcourez notre univers et découvrez des projets novateurs, des sites d'exceptions, des réalisations des plus simples aux plus originales.
Avec Star®, Lumière®, Acoustics®, Imprimé, ou encore Trempo®, Barrisol® propose des produits toujours plus innovants pour vous accompagner dans tous vos projets.

Proud of our 45 years experience, we decorate, renovate and embellish any type of space, thanks to our multitude of solutions that combine technique, performance and aesthetics.

Enter our universe and discover innovative projects and realizations from the simplest to the most original.
Star®, Lumière®, Acoustics®, Printed, or Trempo®, and all Barrisol® innovative products makes it the best choice for your projects.

Mit Barrisol® stehen Ihnen mehr als 45 Jahre Erfahrung zur Verfügung, um Ihr Zuhause mit Fachwissen, hoher Qualität, Leistung und Design auszustatten oder zu erneuern.

Besuchen Sie unser Universum, um innovative Projekte sowie ausgefallene und vielseitige Verwendungsmöglichkeiten zu entdecken.
Barrisol® bietet zukunftsorientierte und innovative Produkte an, wie Star®, Lumière®, Acoustics®, Imprimé oder Trempo®, und begleitet Sie in allen Ihren Projekten.

Pour en savoir plus et découvrir tous nos projets d'exception, rendez-vous sur notre site

To know more and to discover our universe, visit our website

Besuchen Sie unsere Website, um mehr über Barrisol® - Projekten zu erfahren und zu entdecken

www.barrisol.com

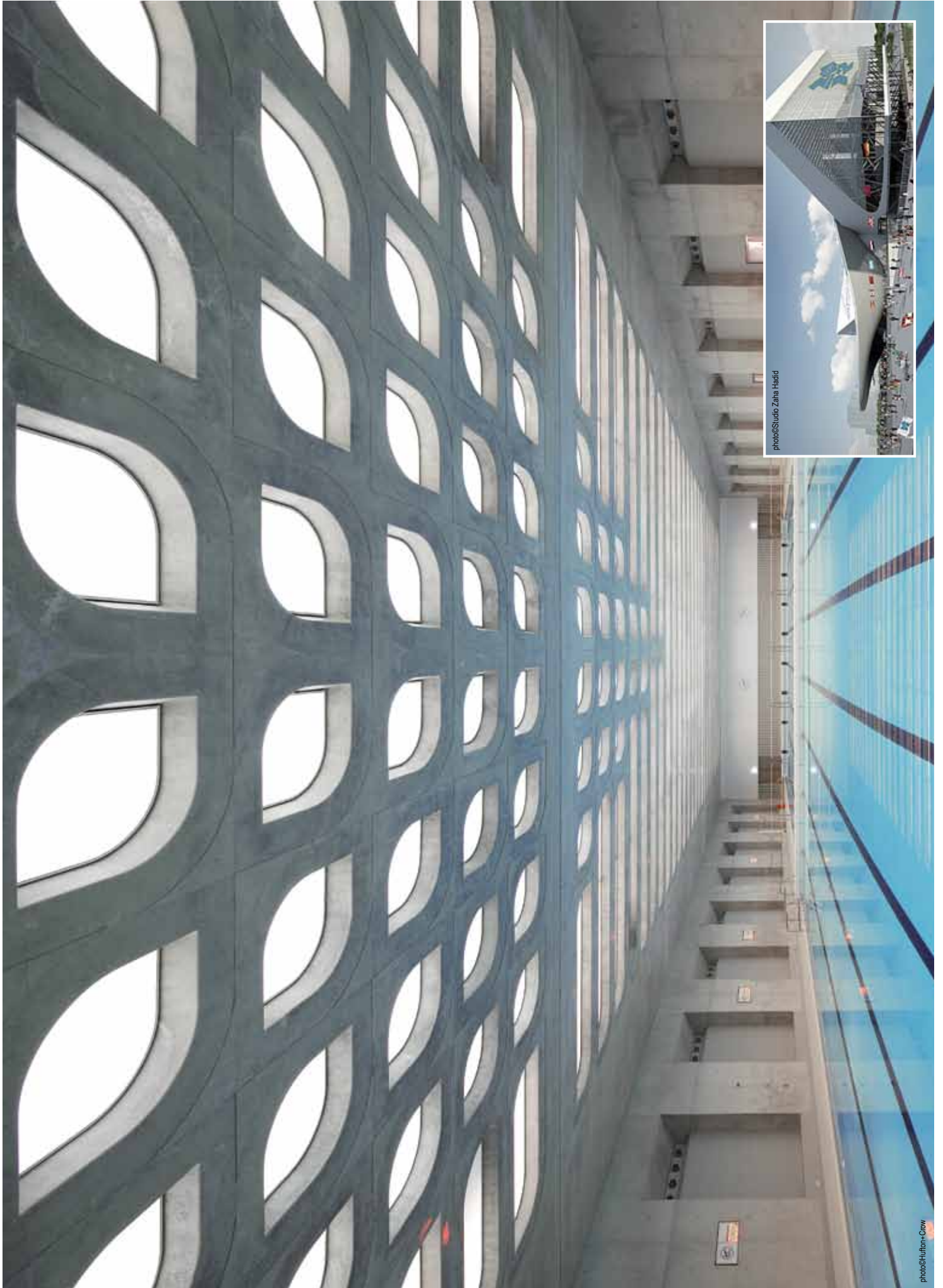

photo©Studio Zaha Hadid

photo©Hutton-Crow

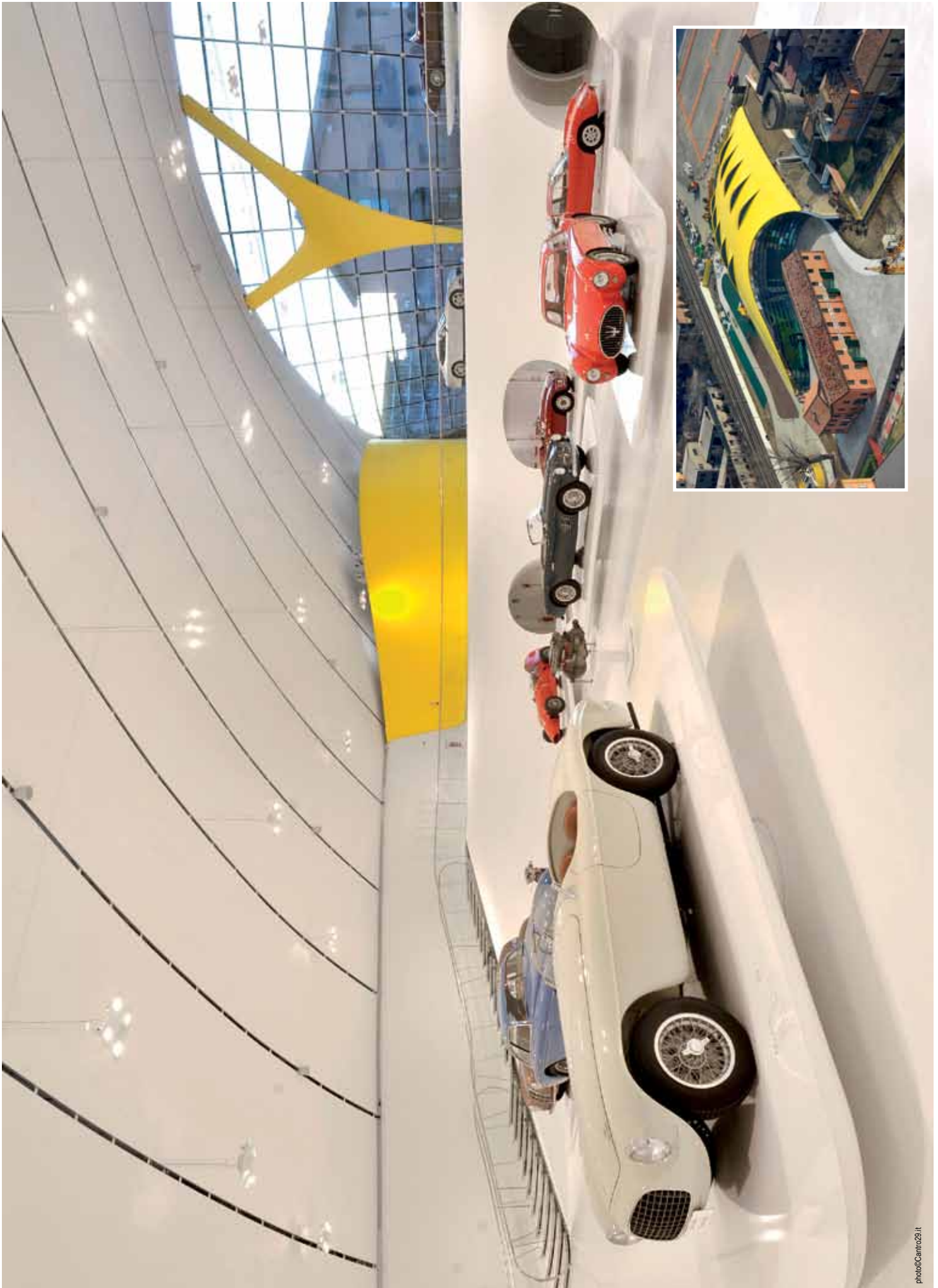

photo©Cantiro23.it



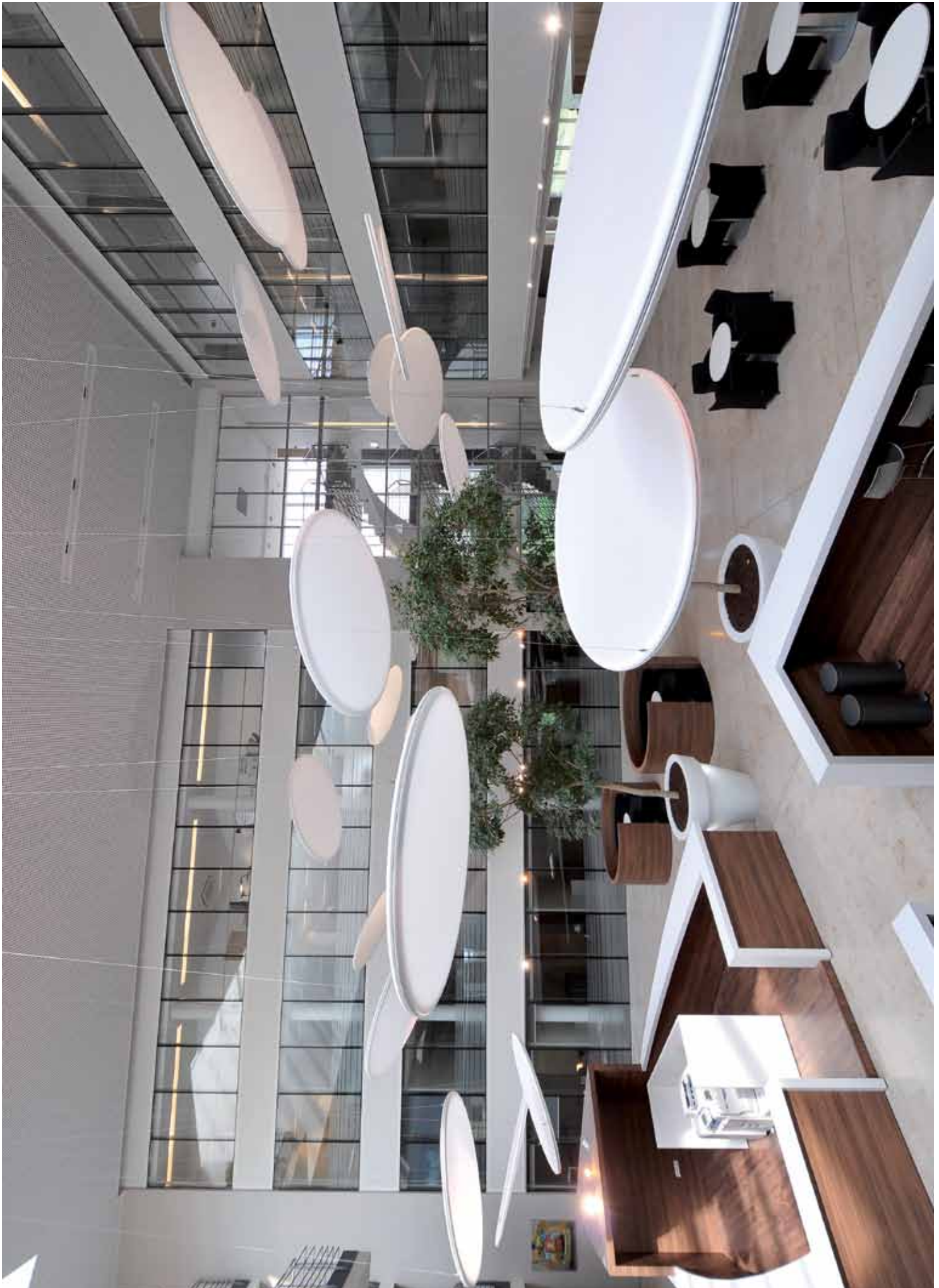



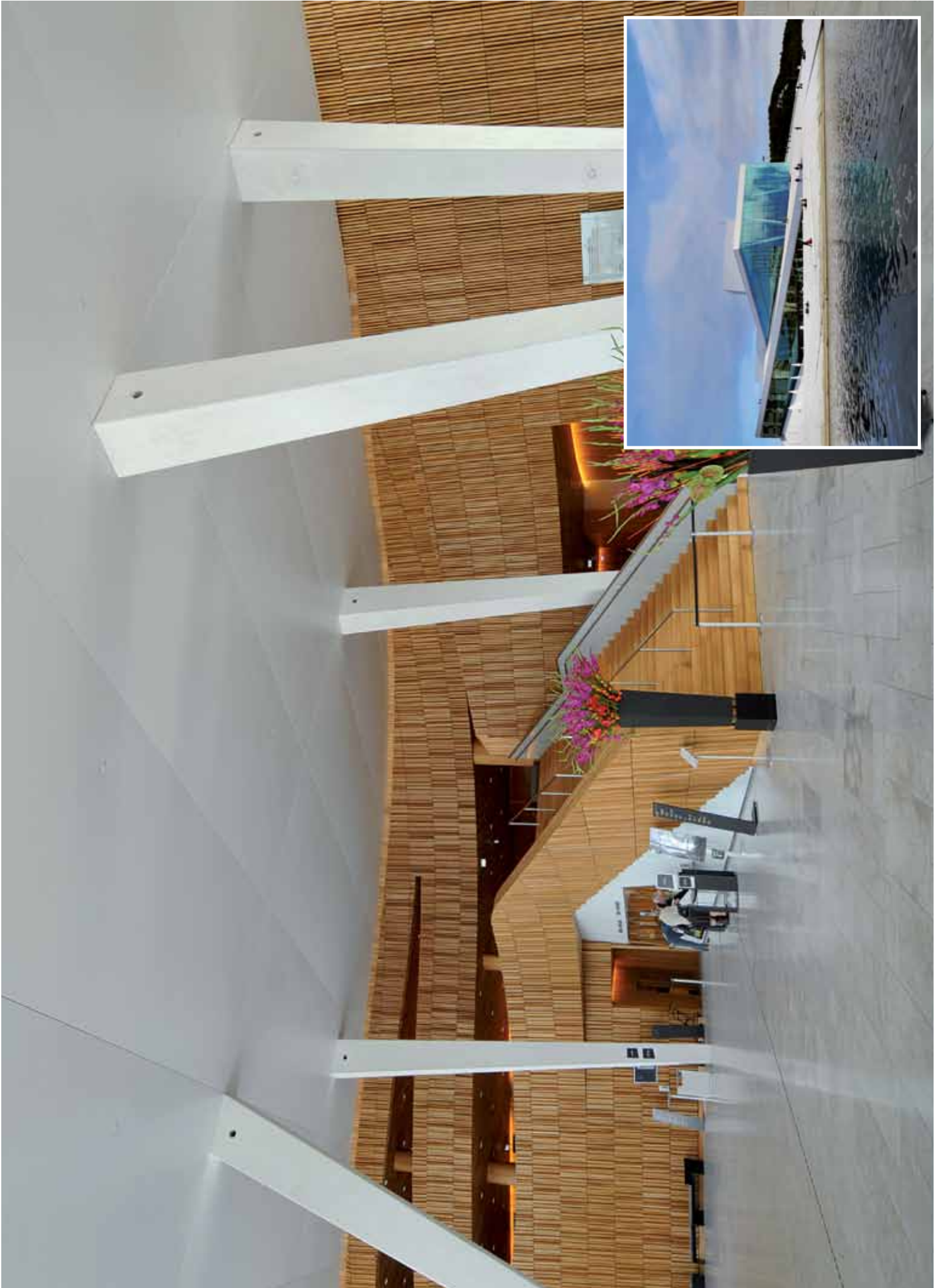





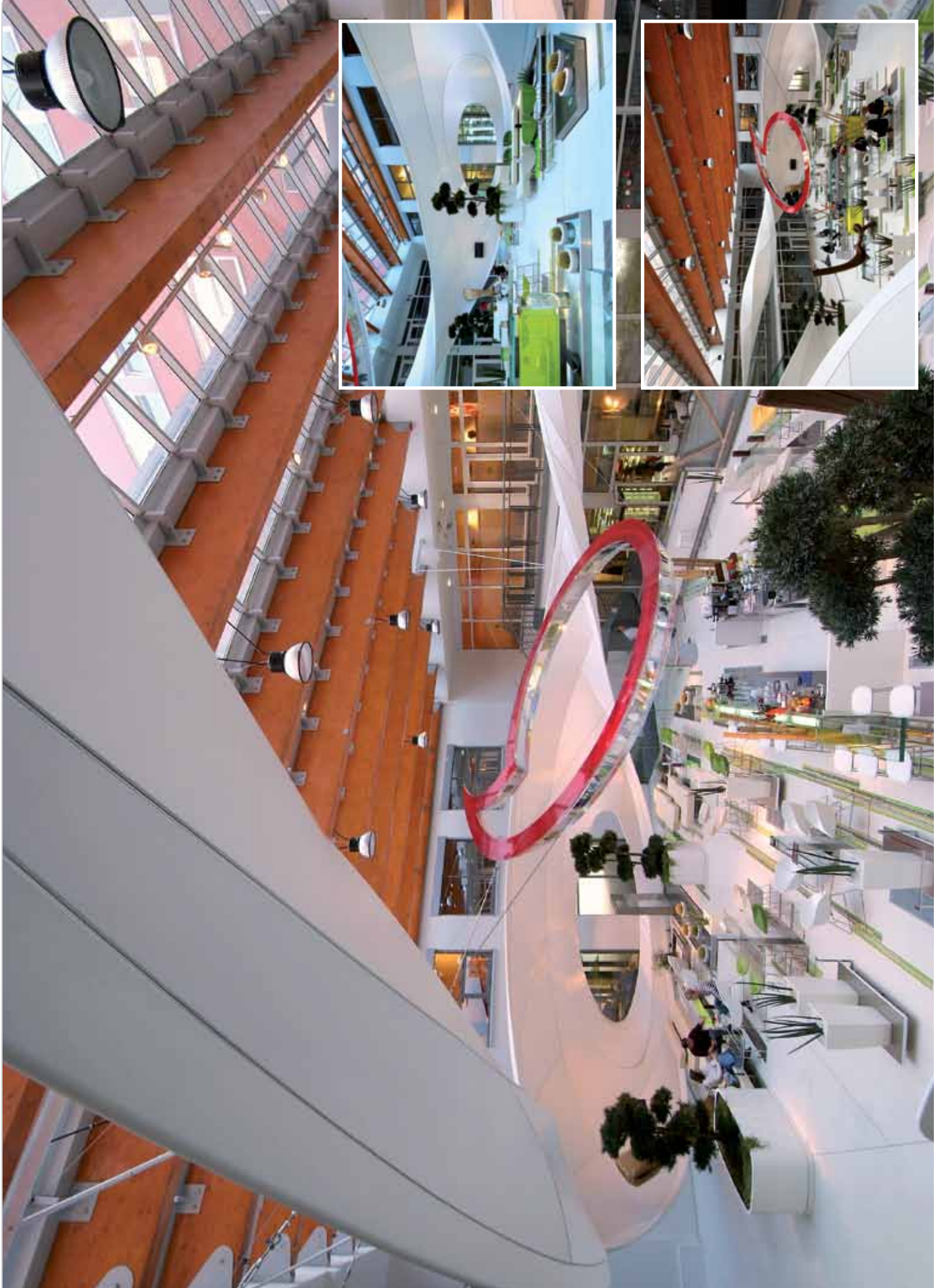

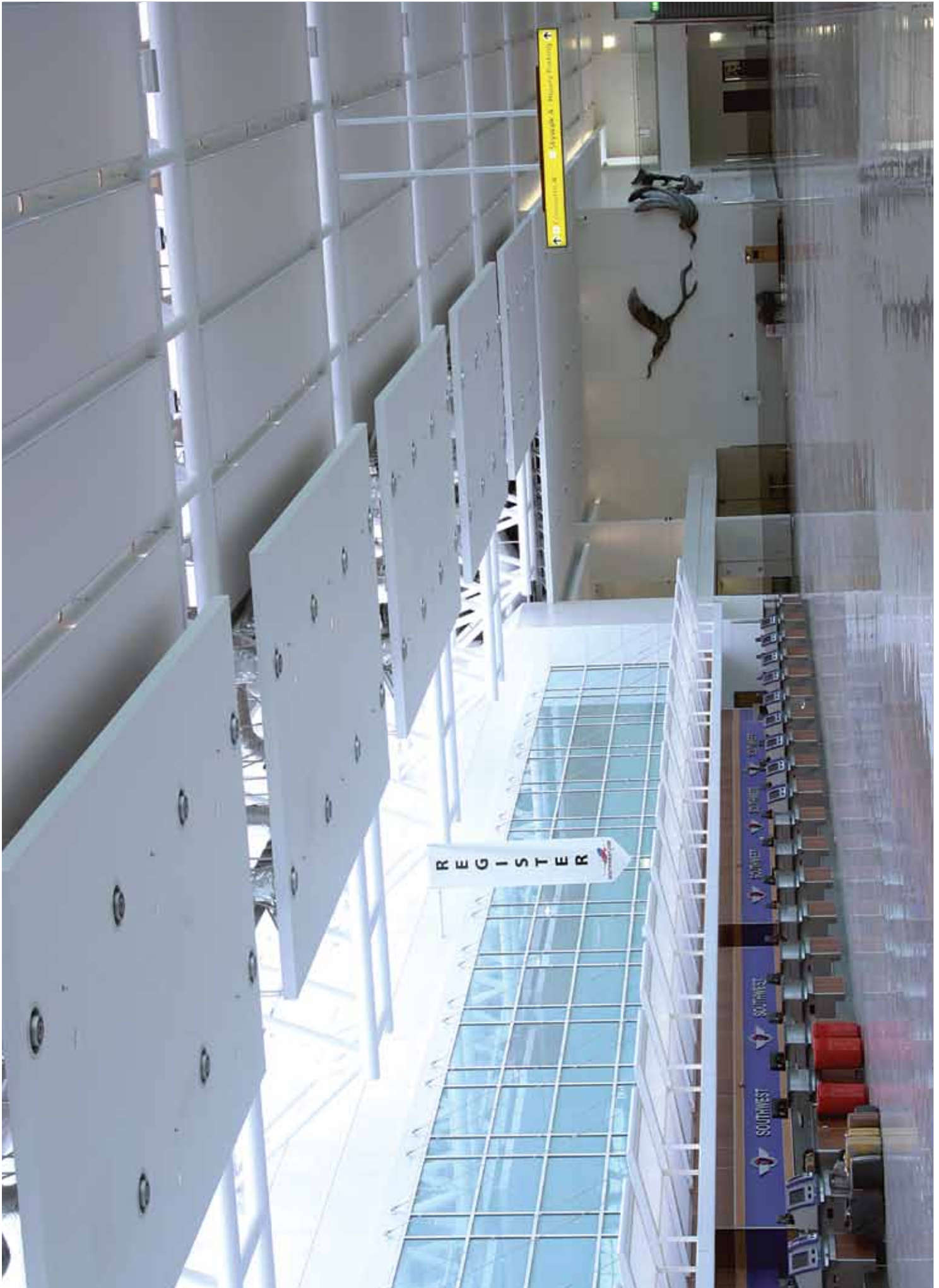

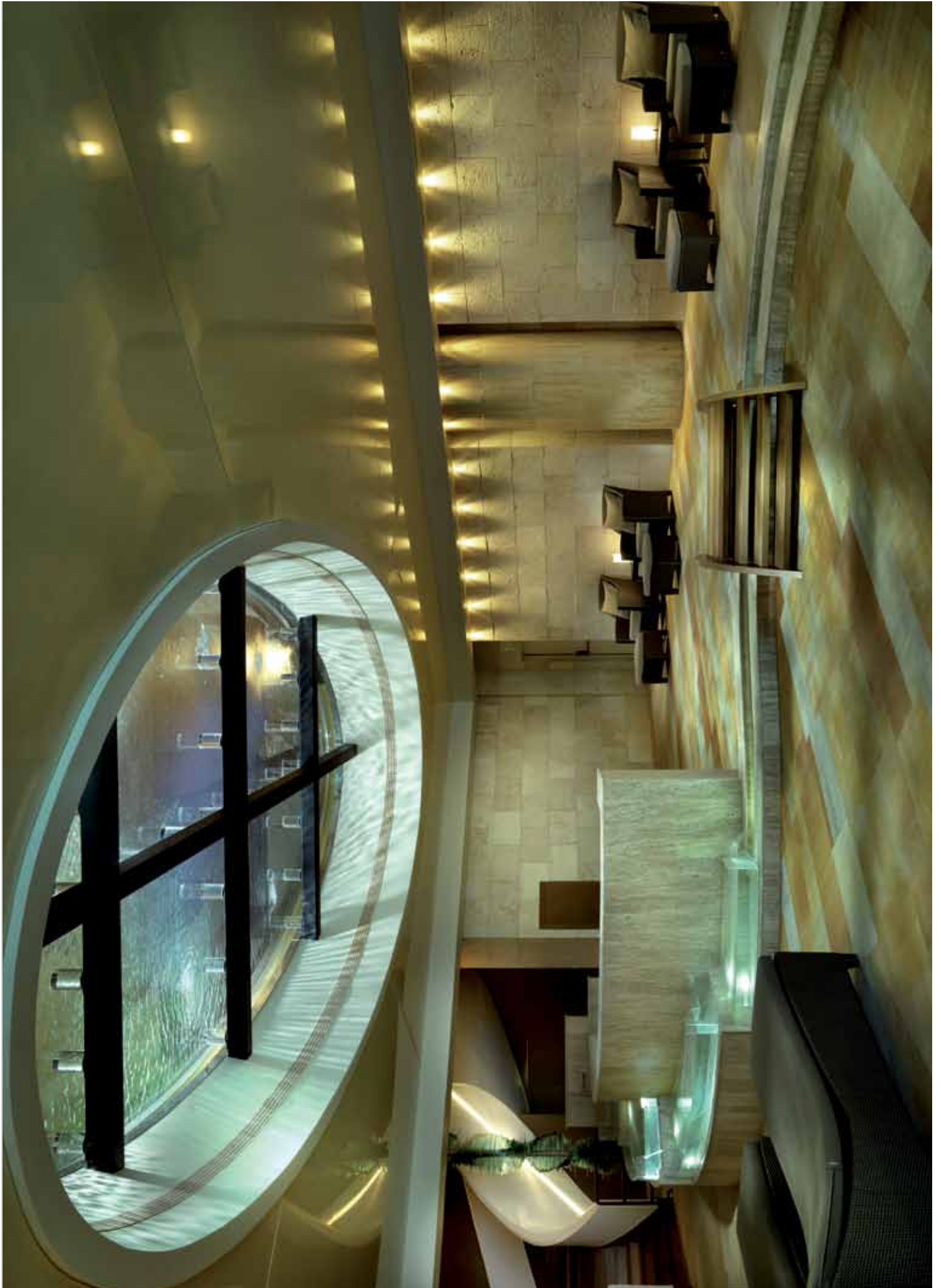





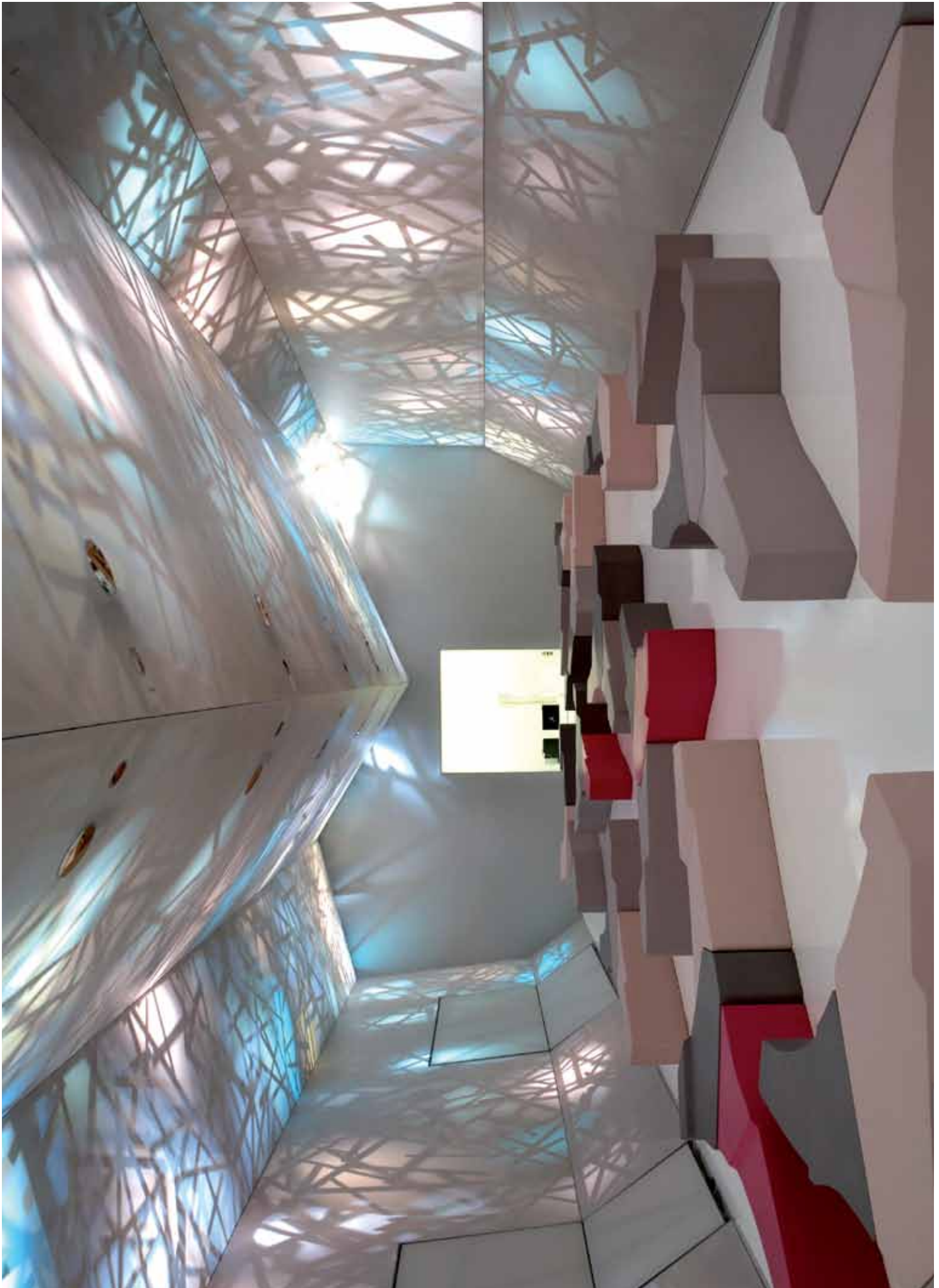

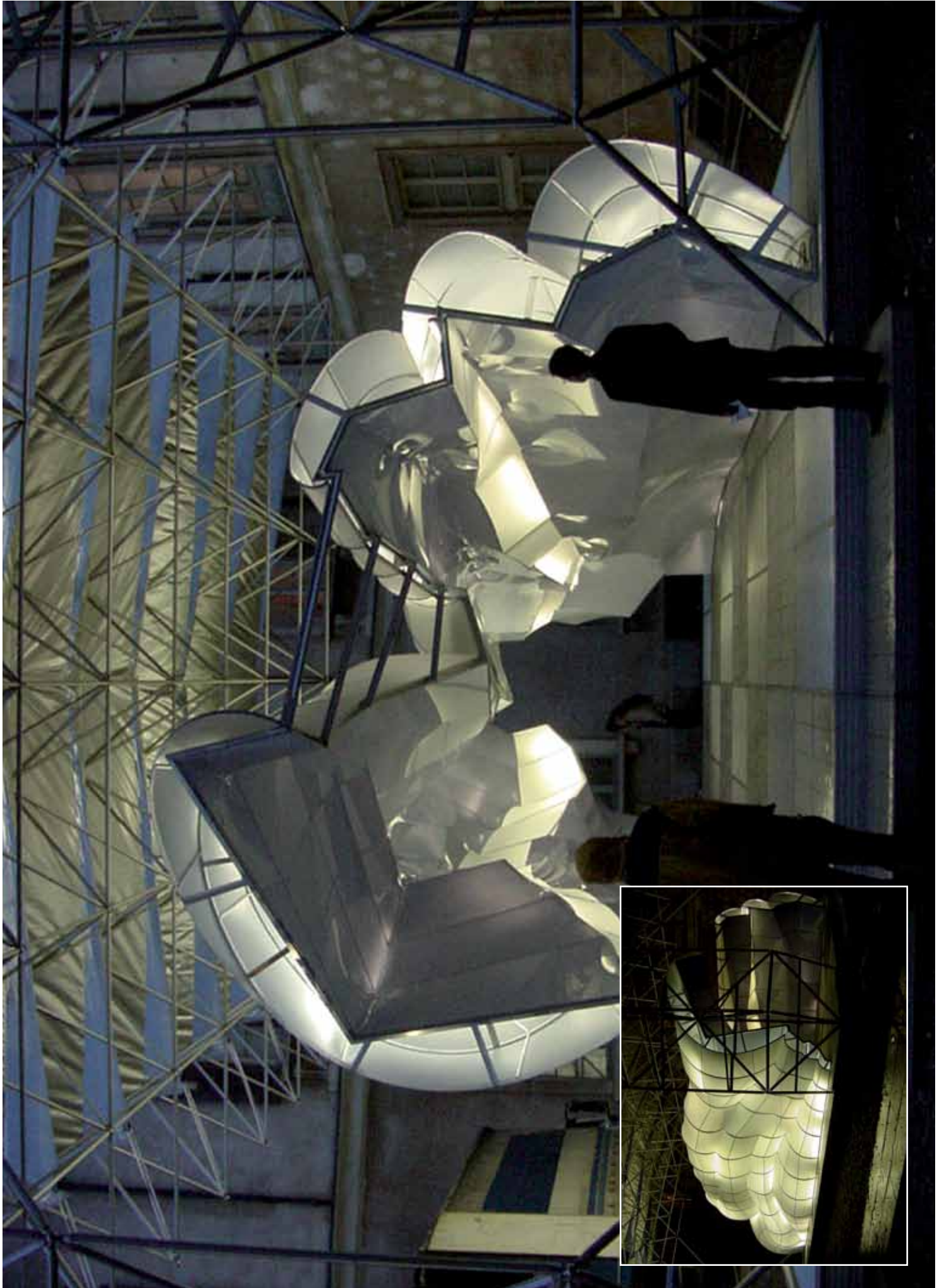



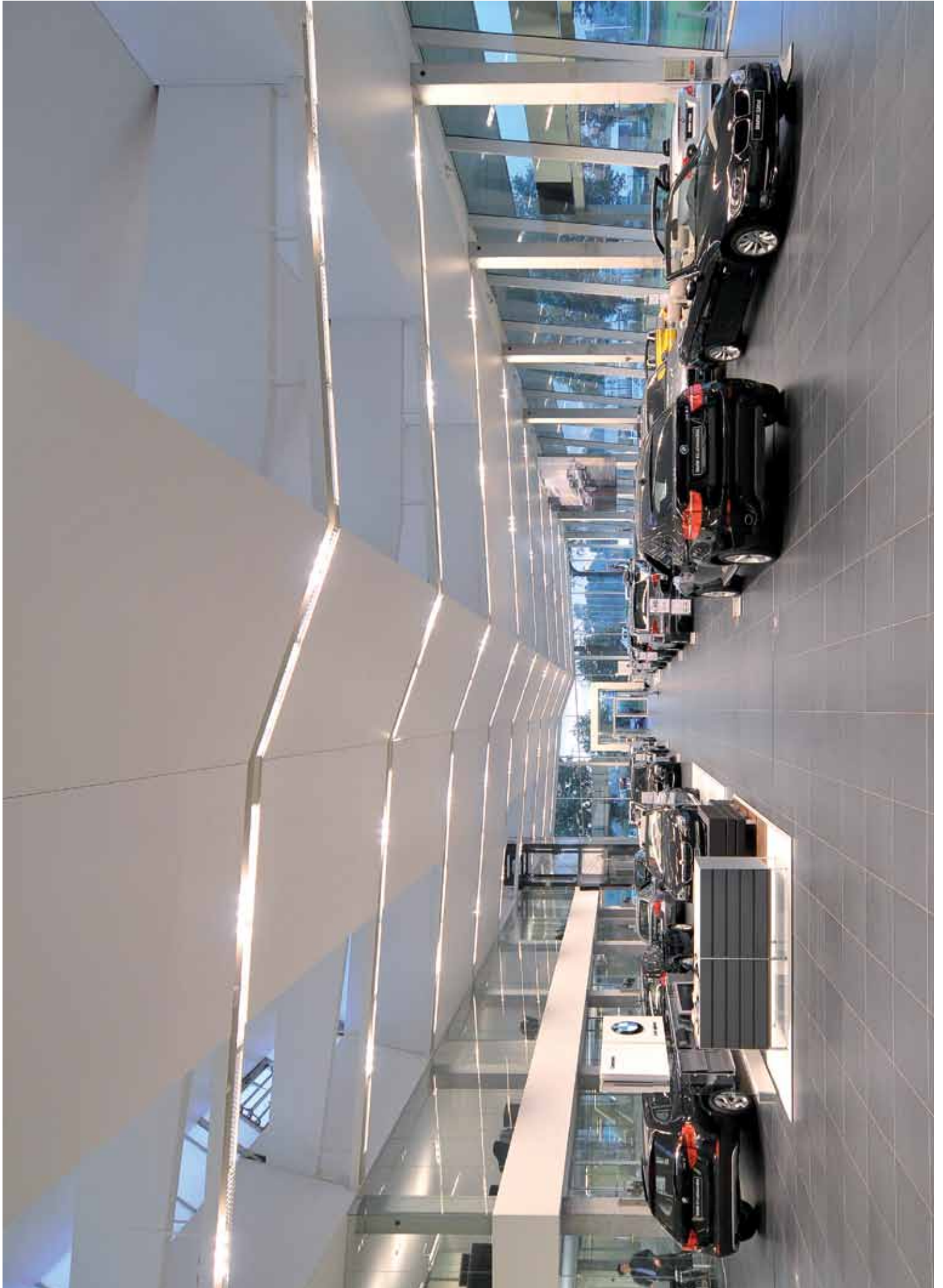







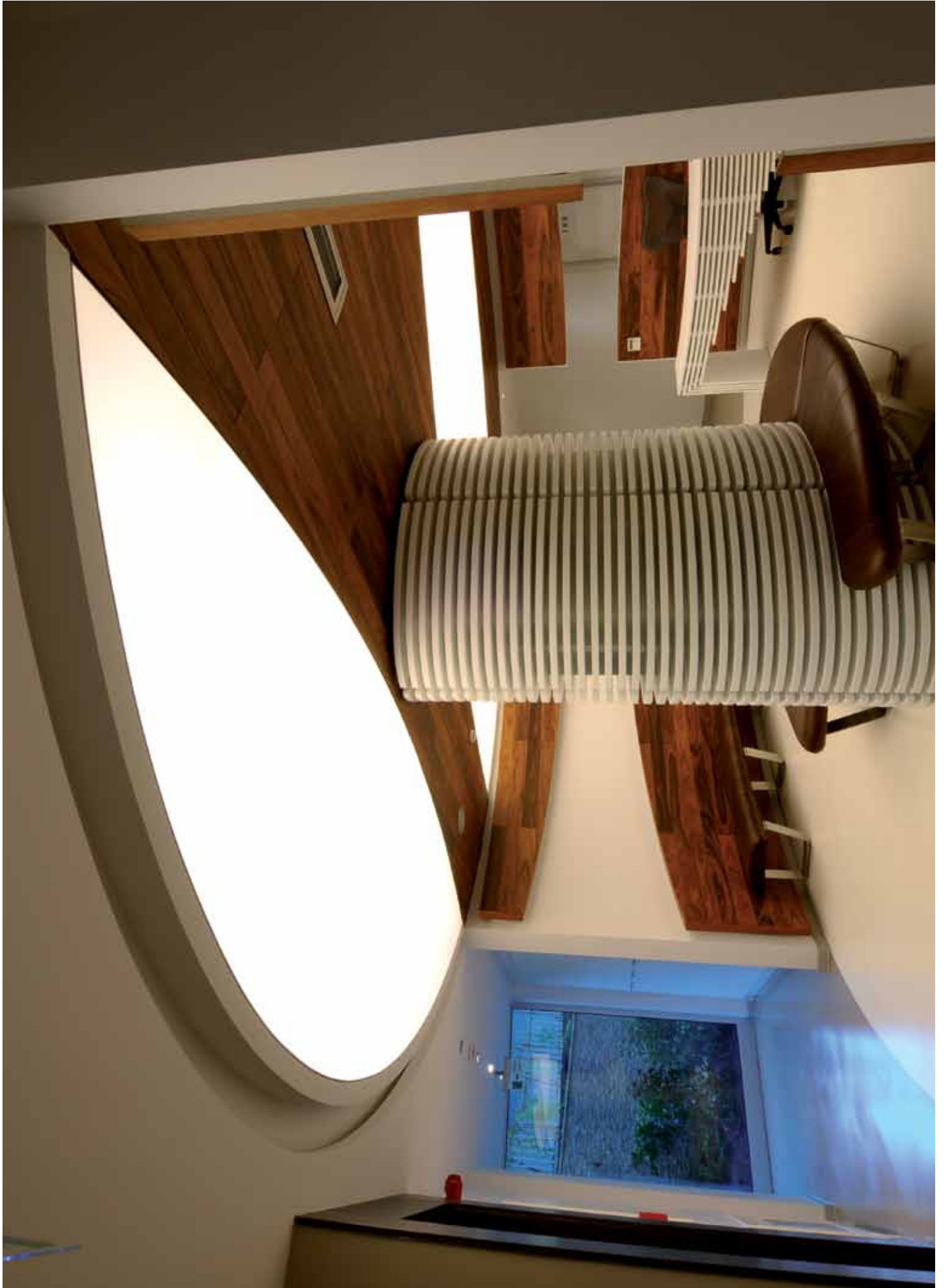

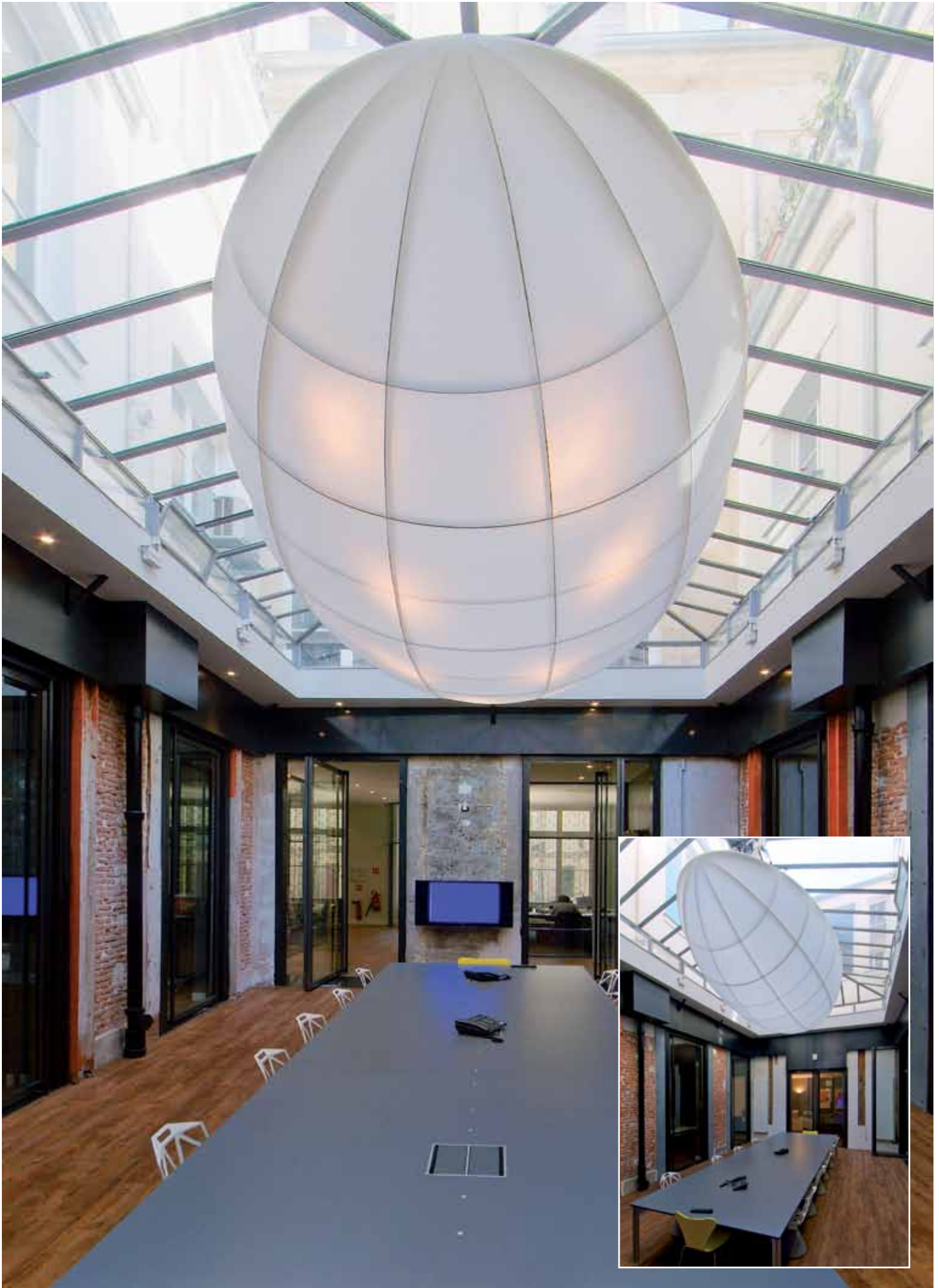

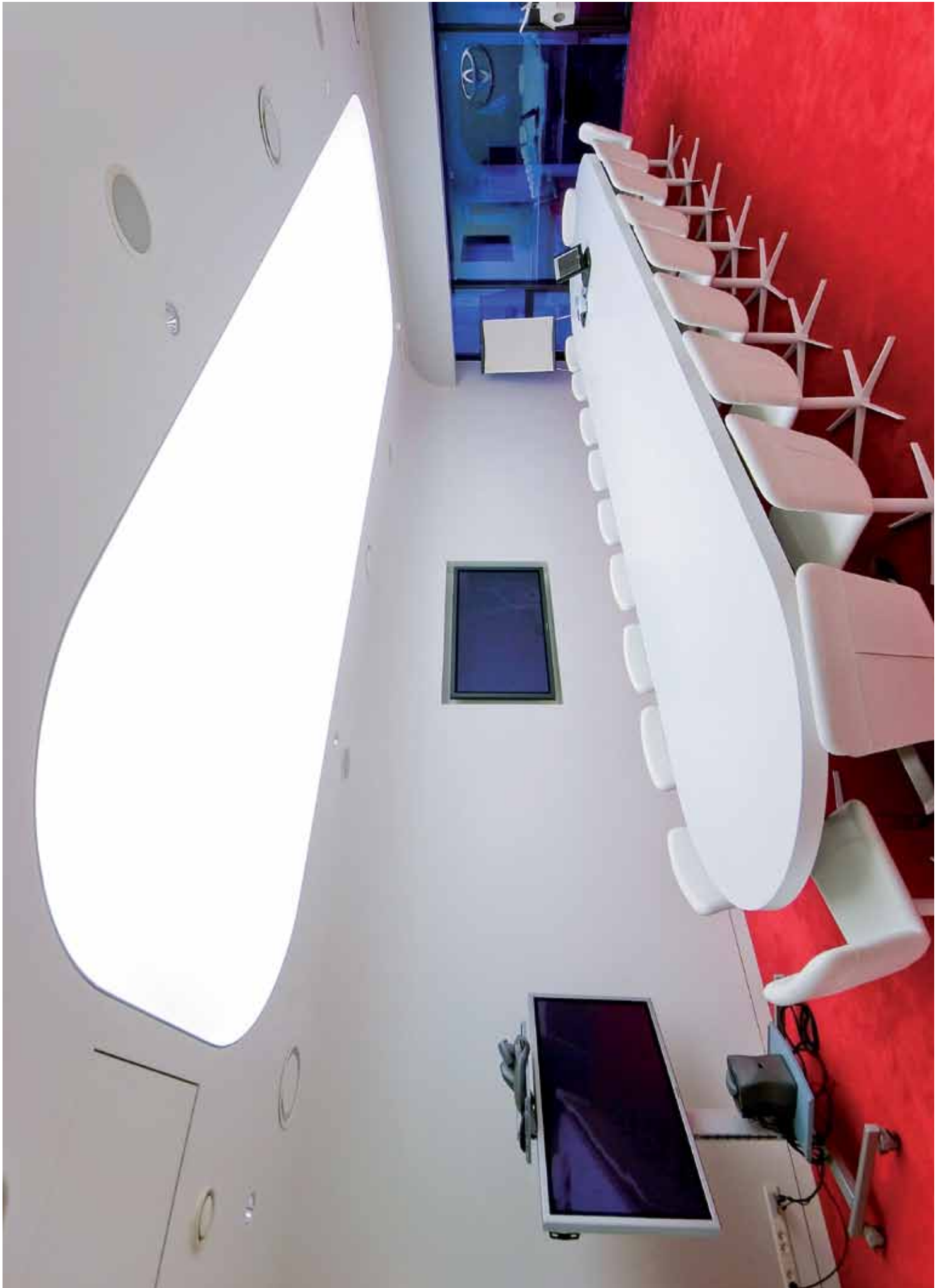



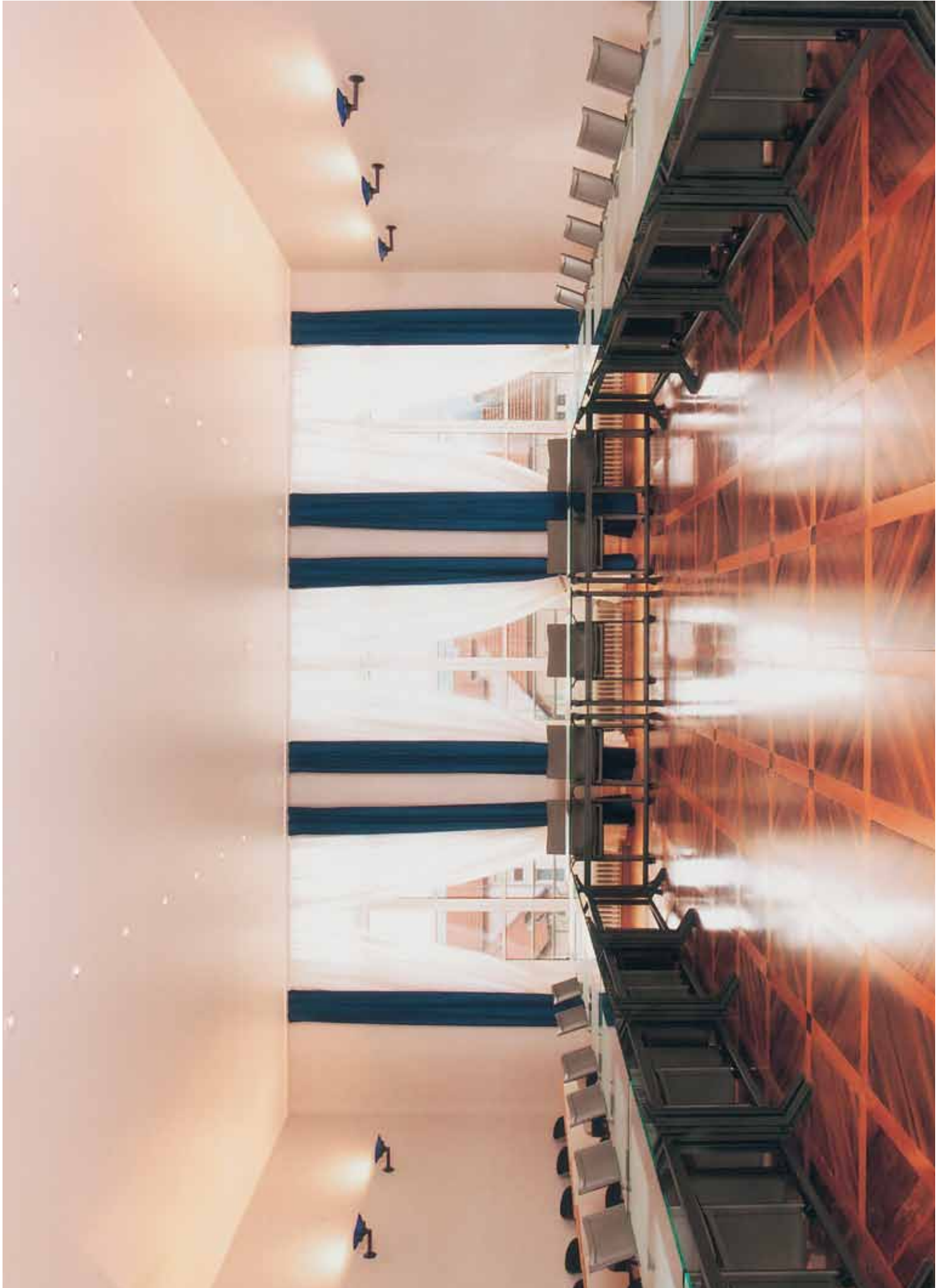

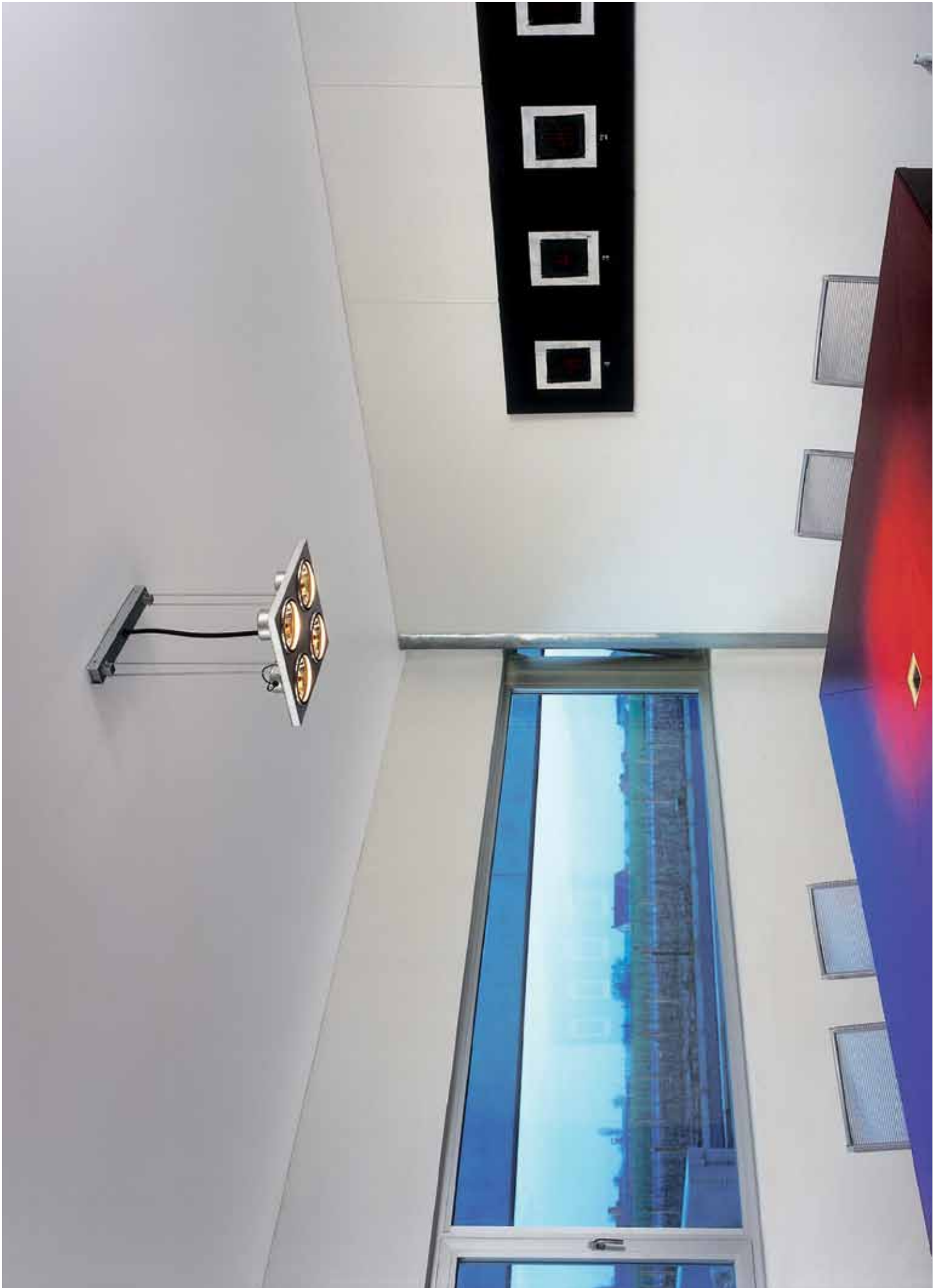

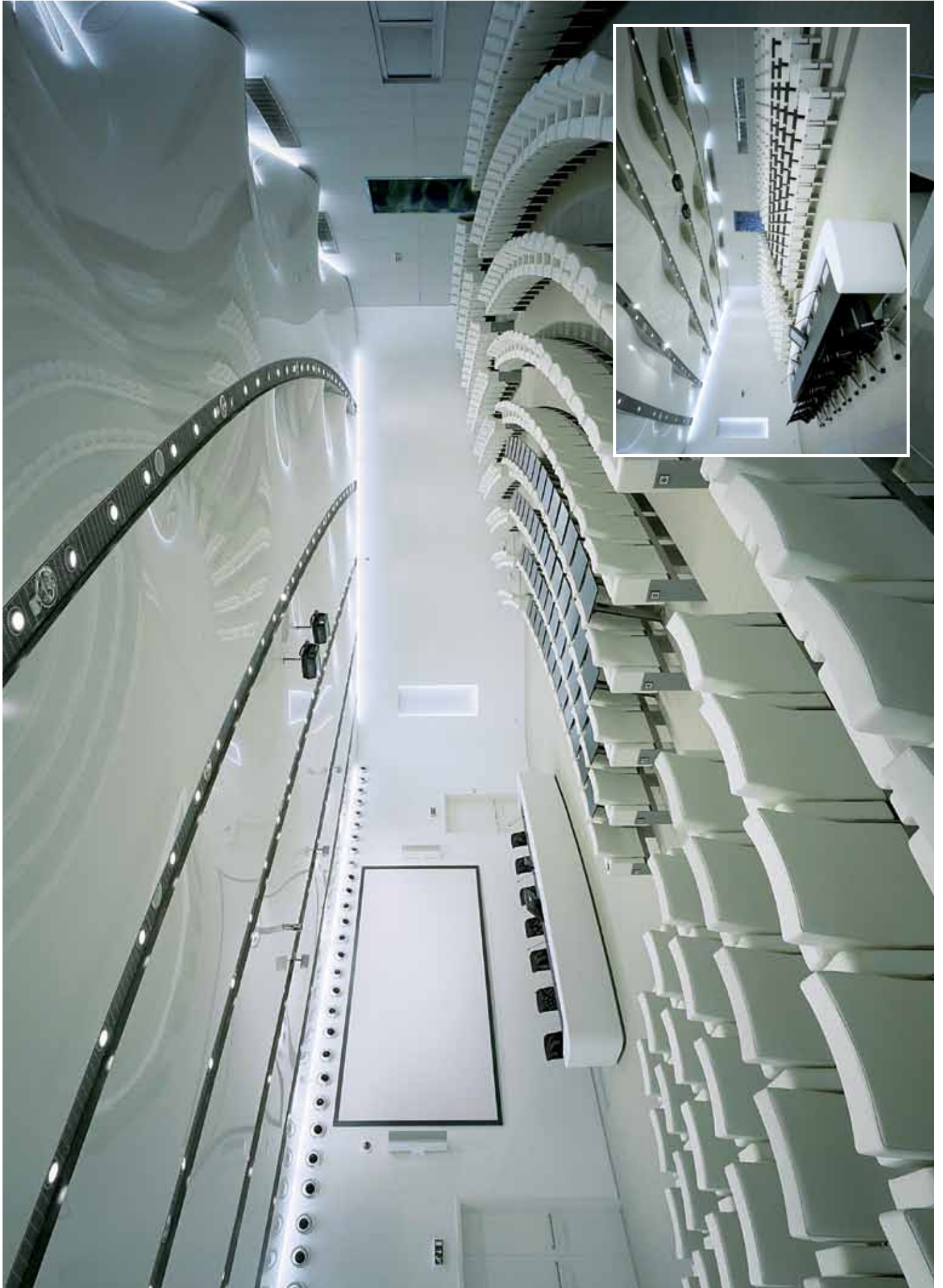





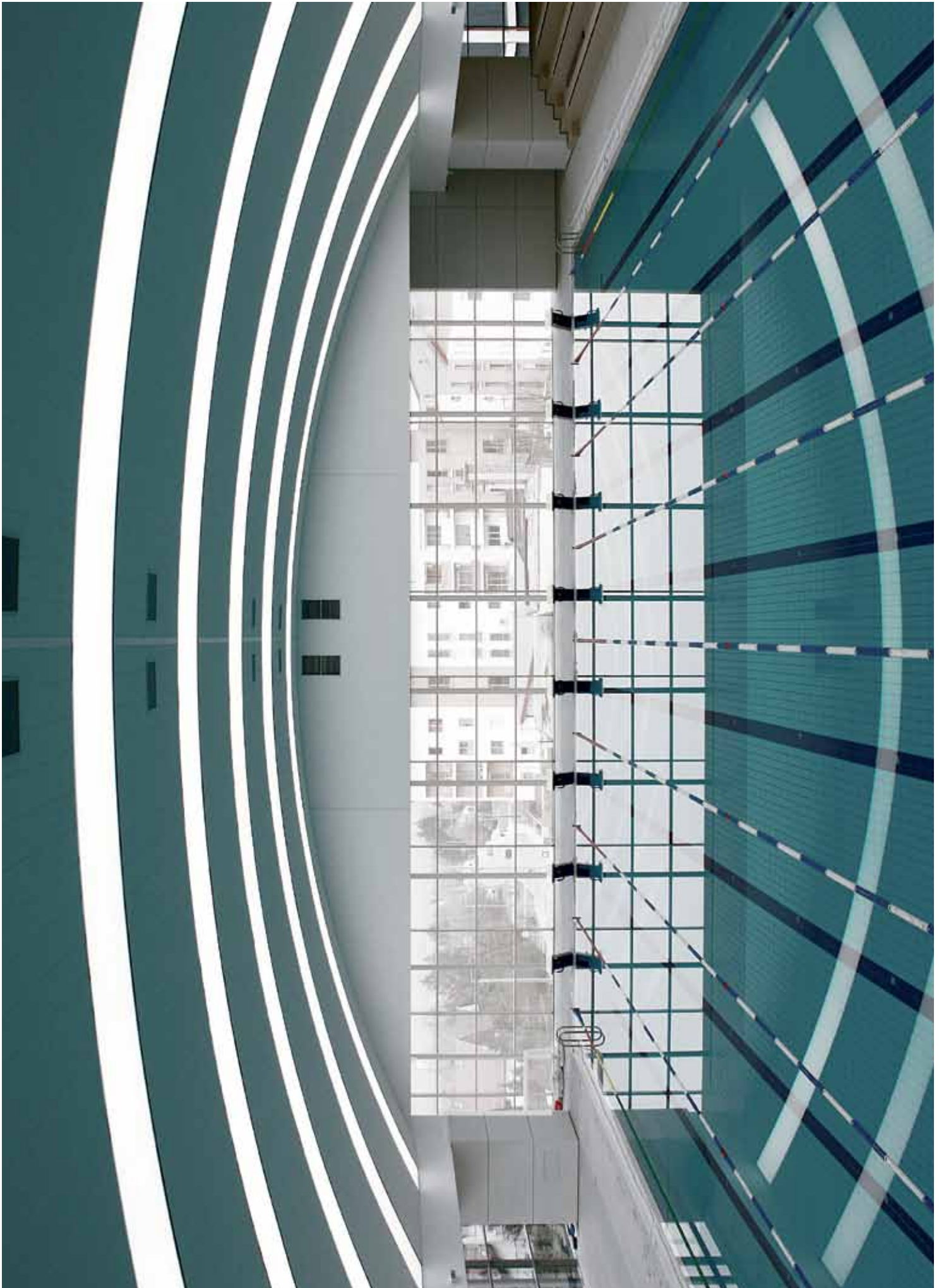

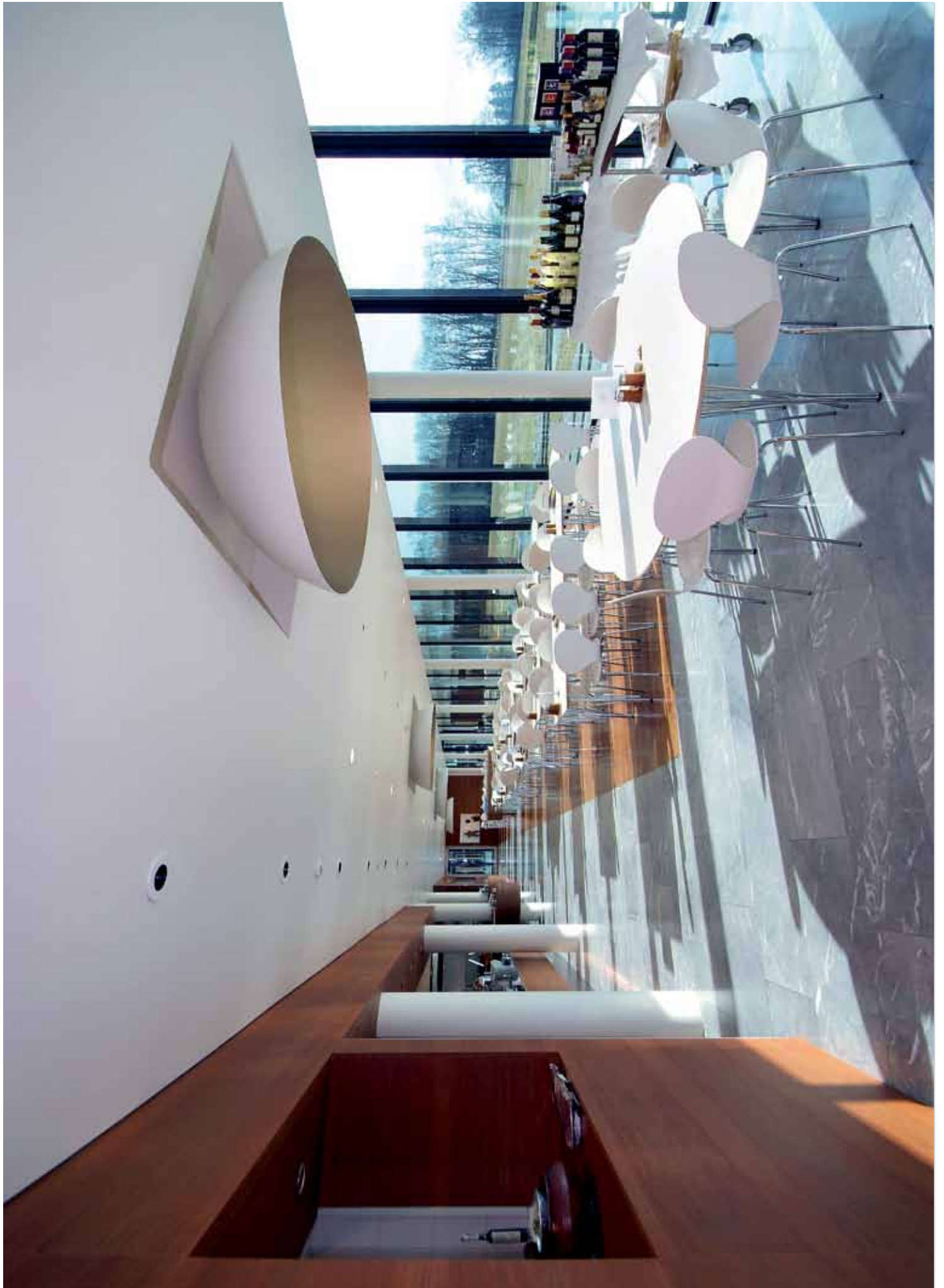

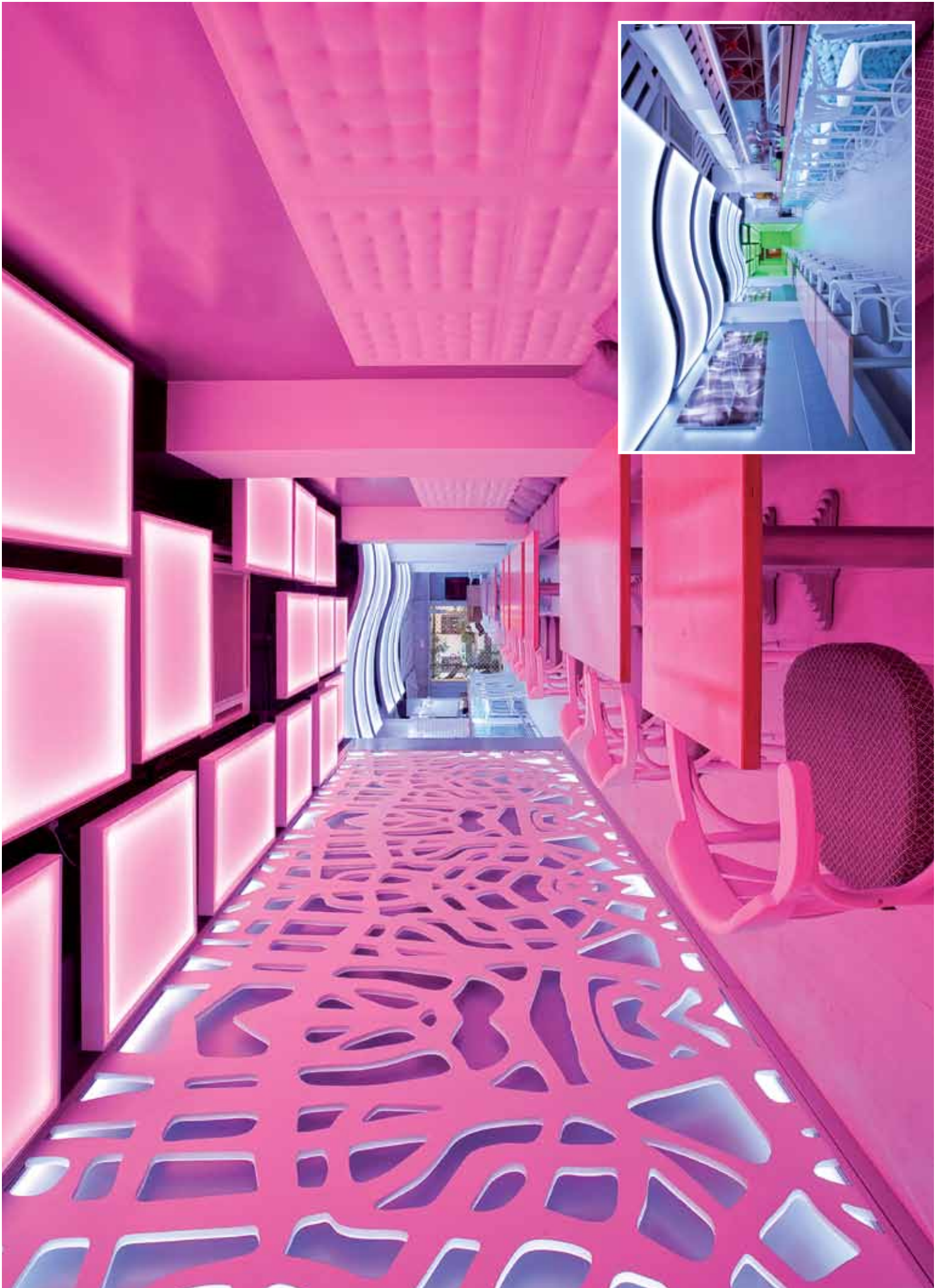

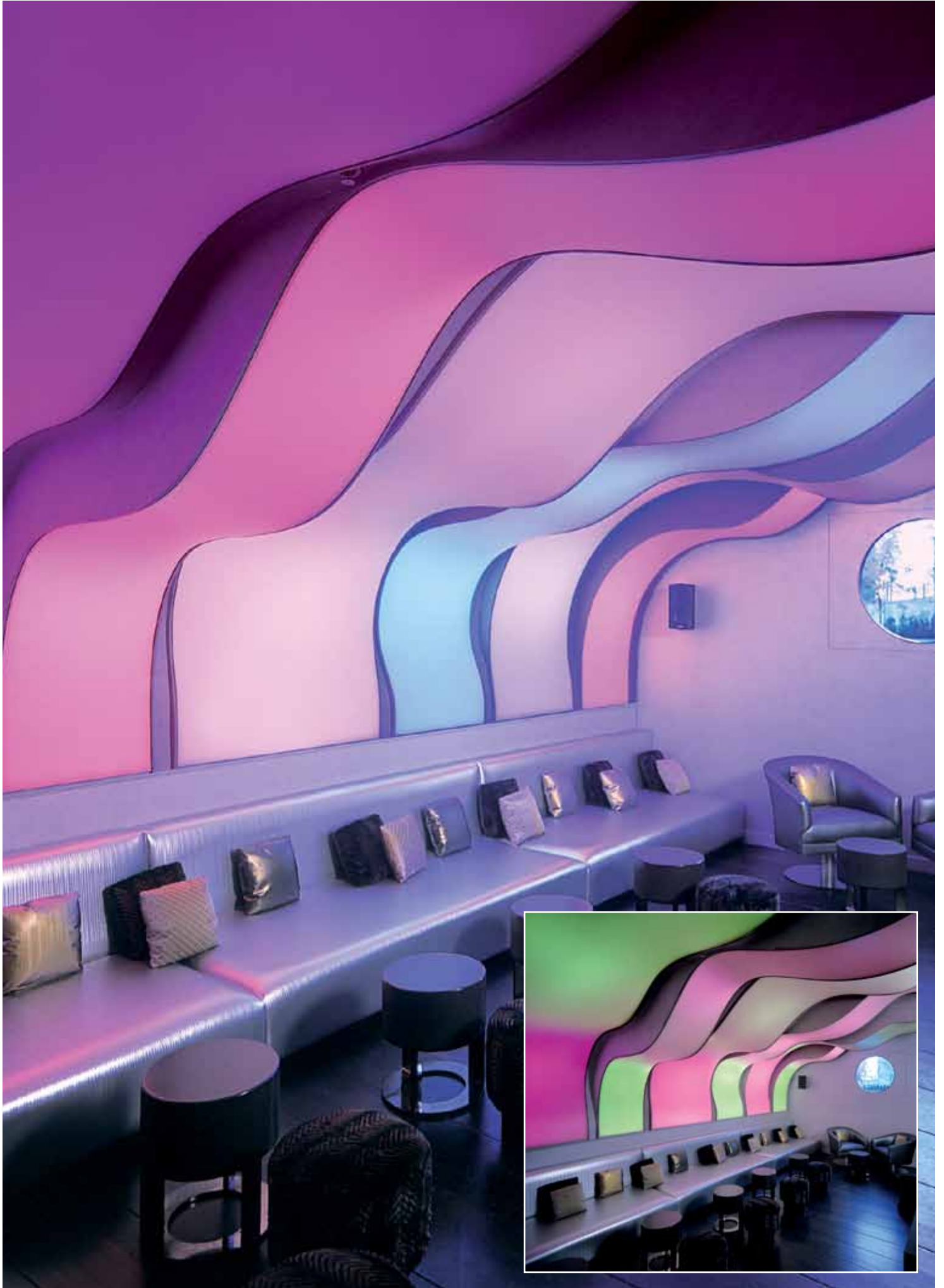





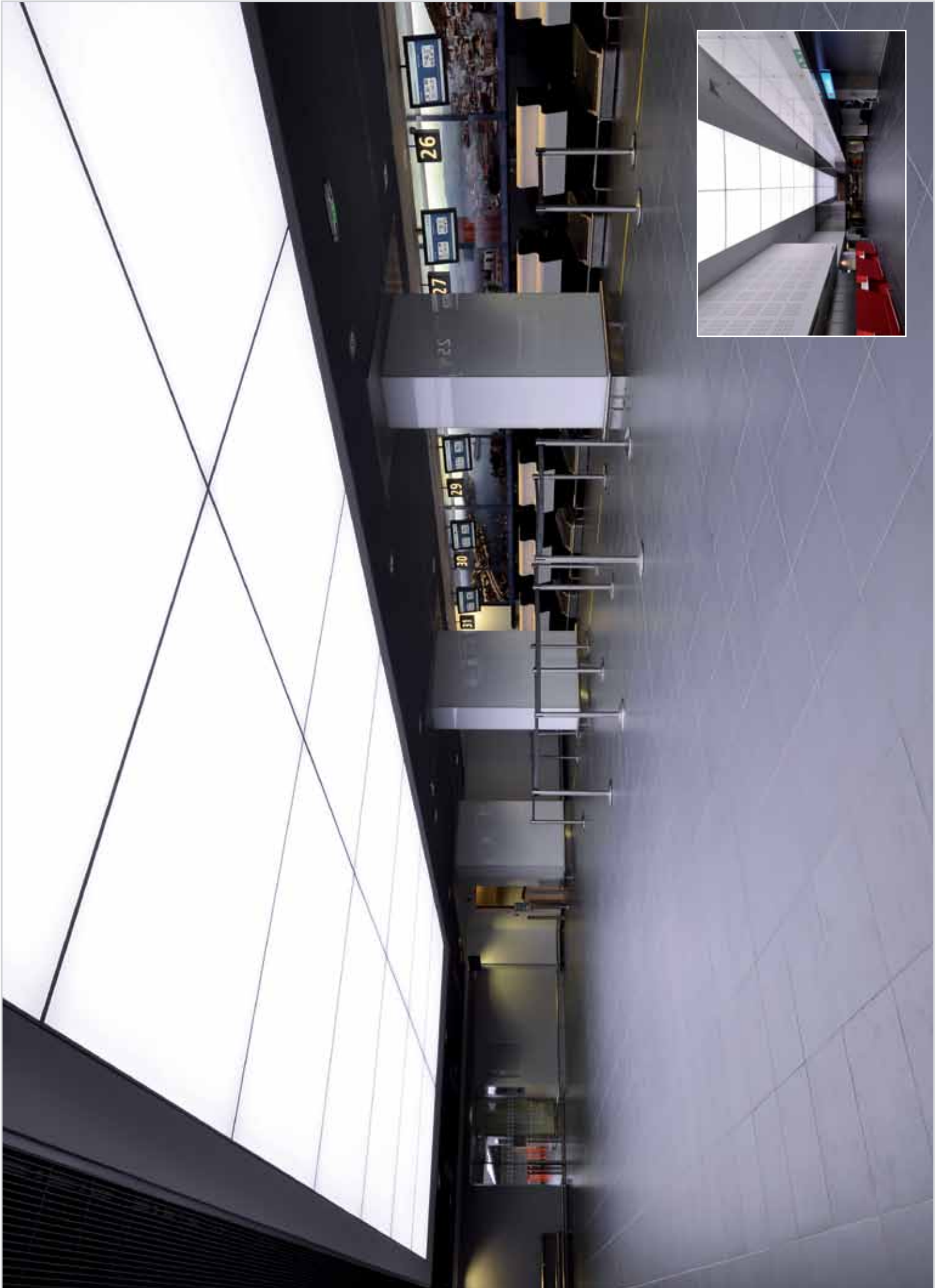

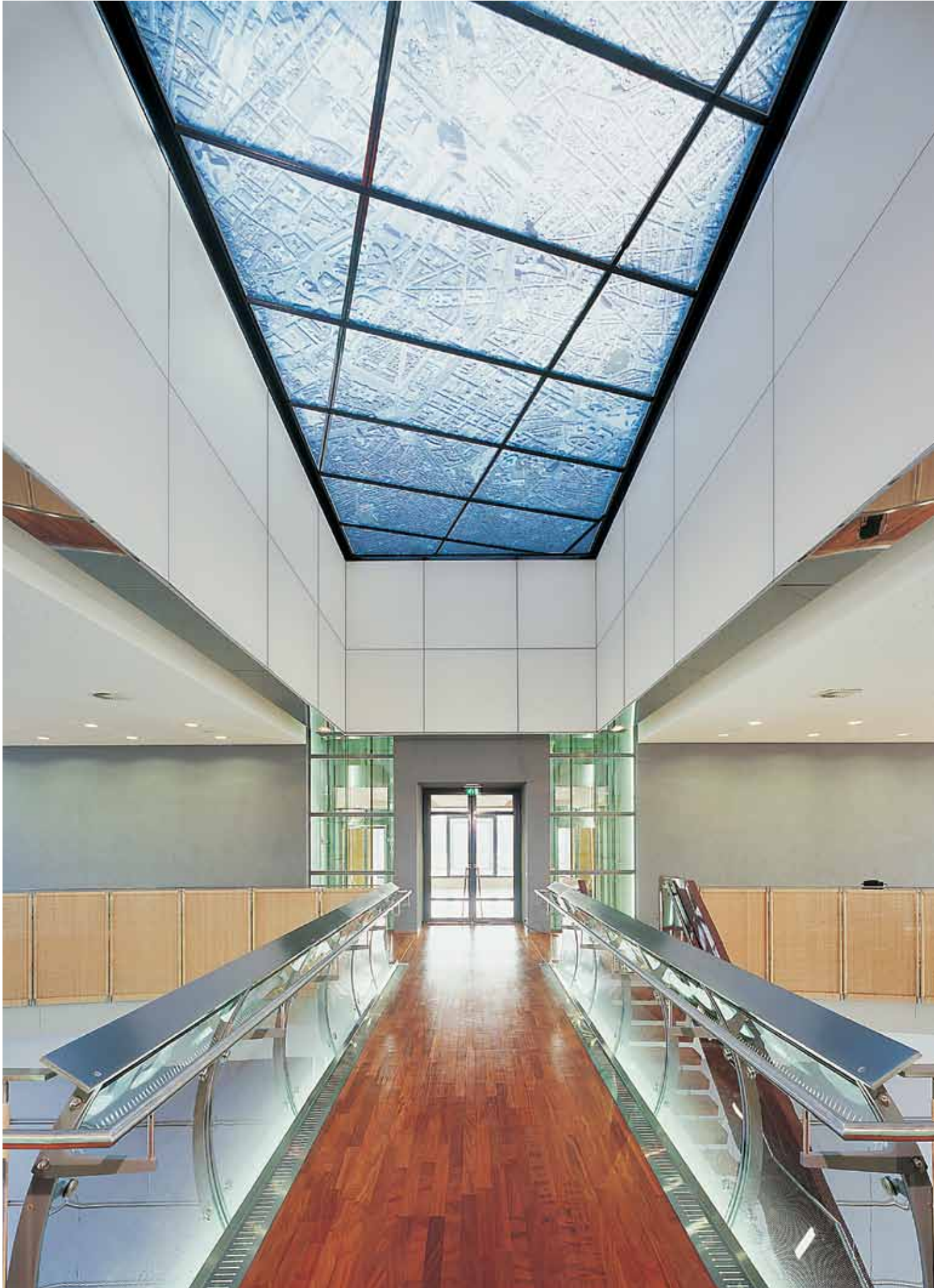











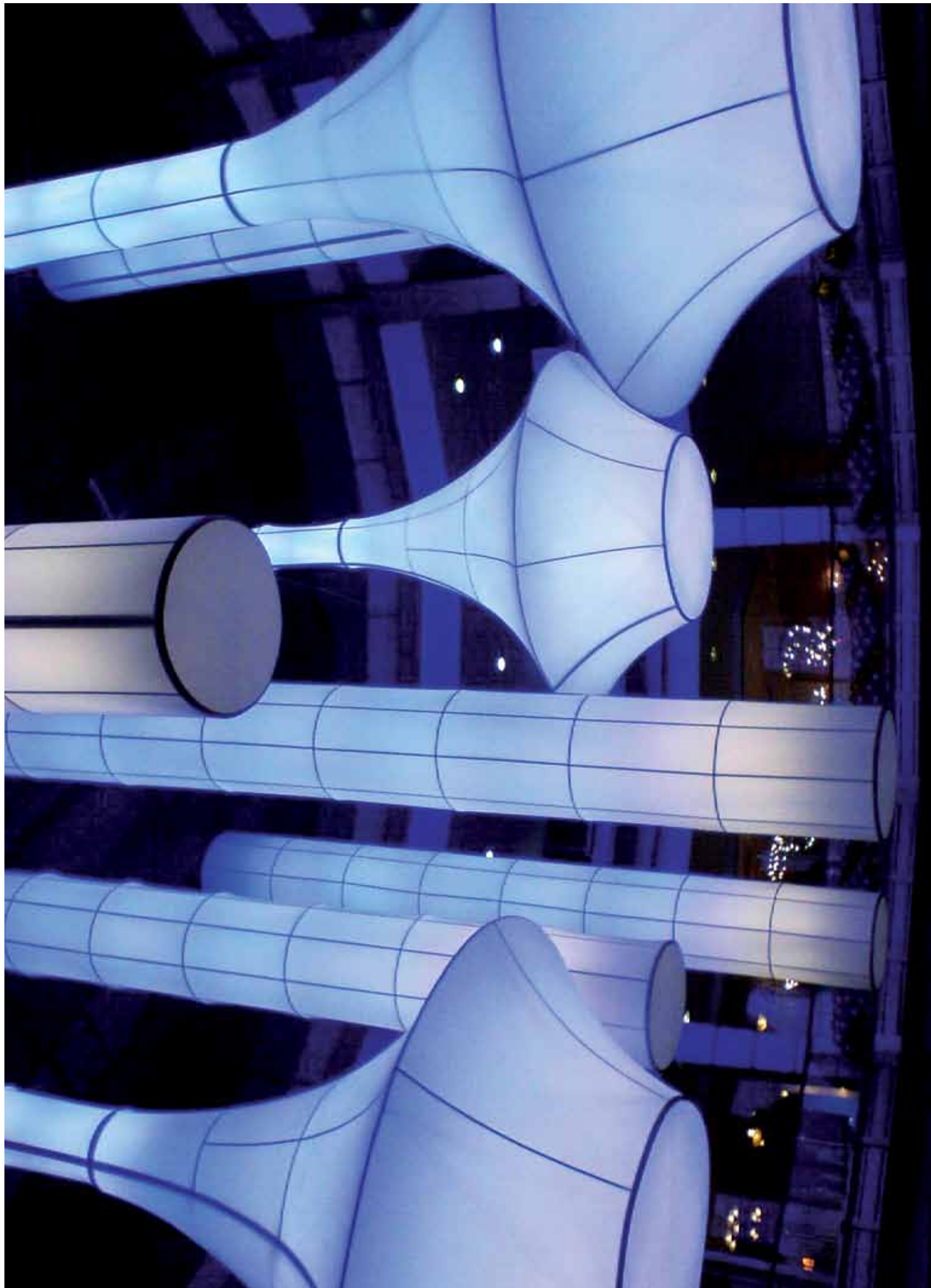

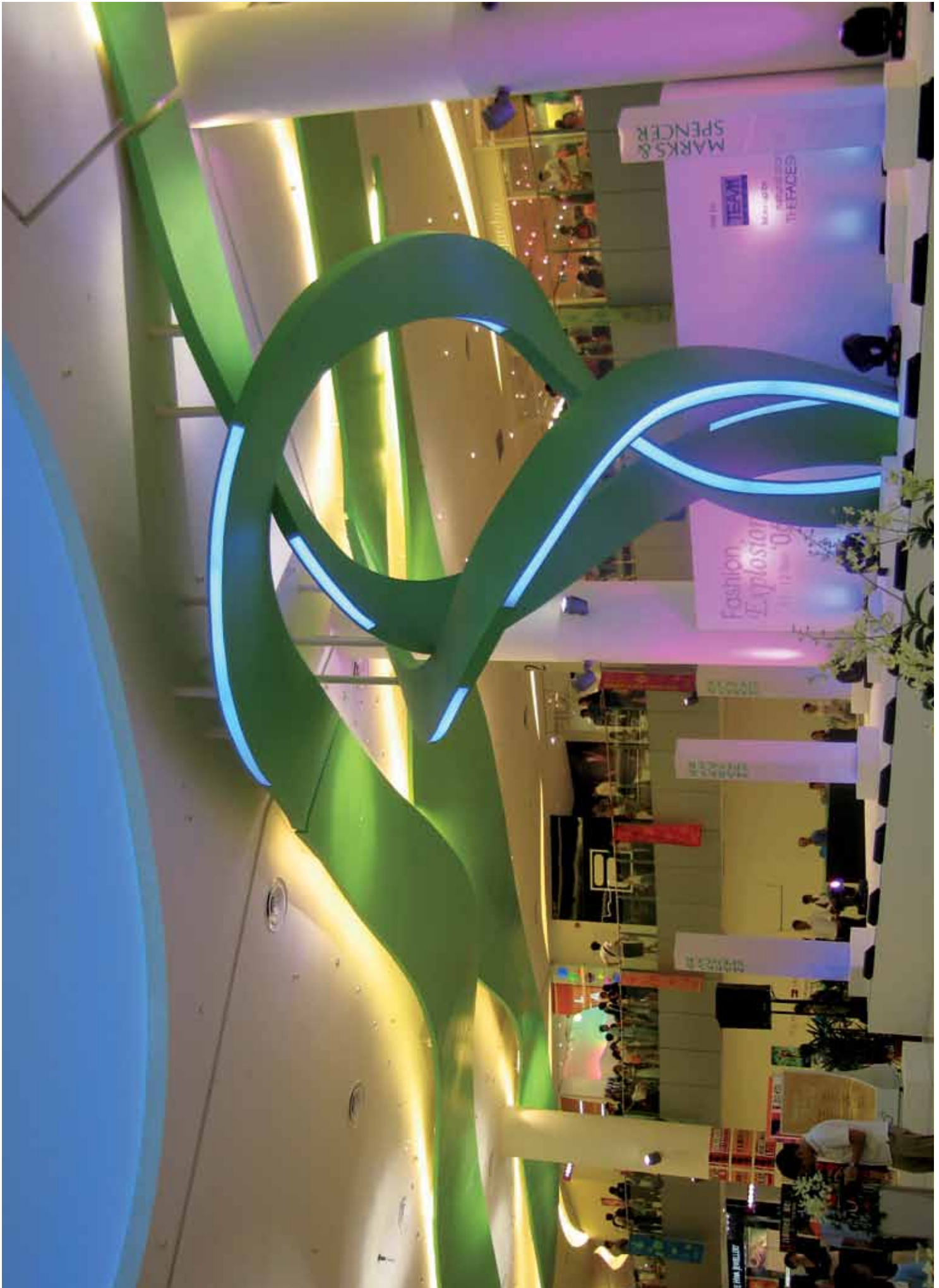

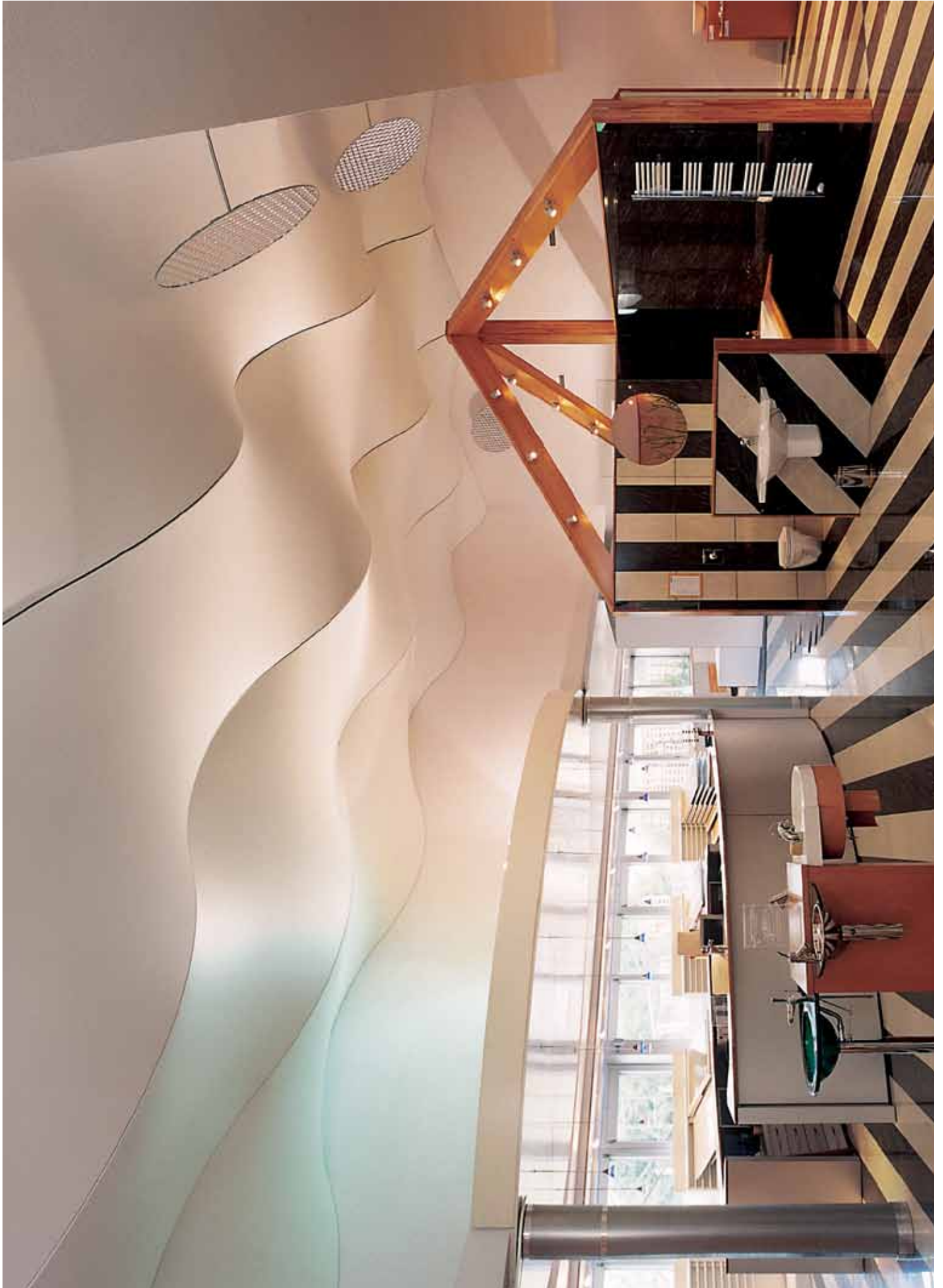



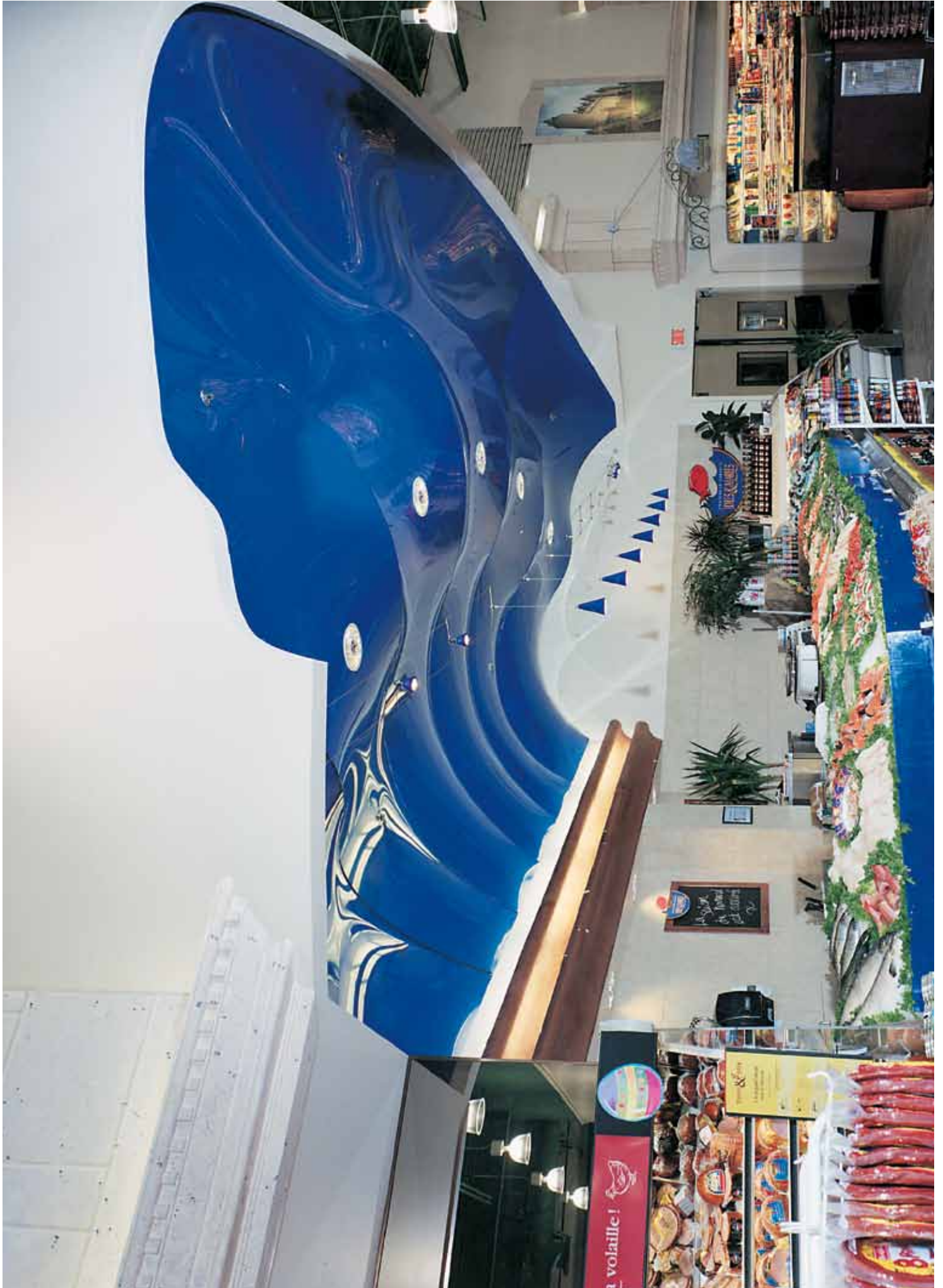







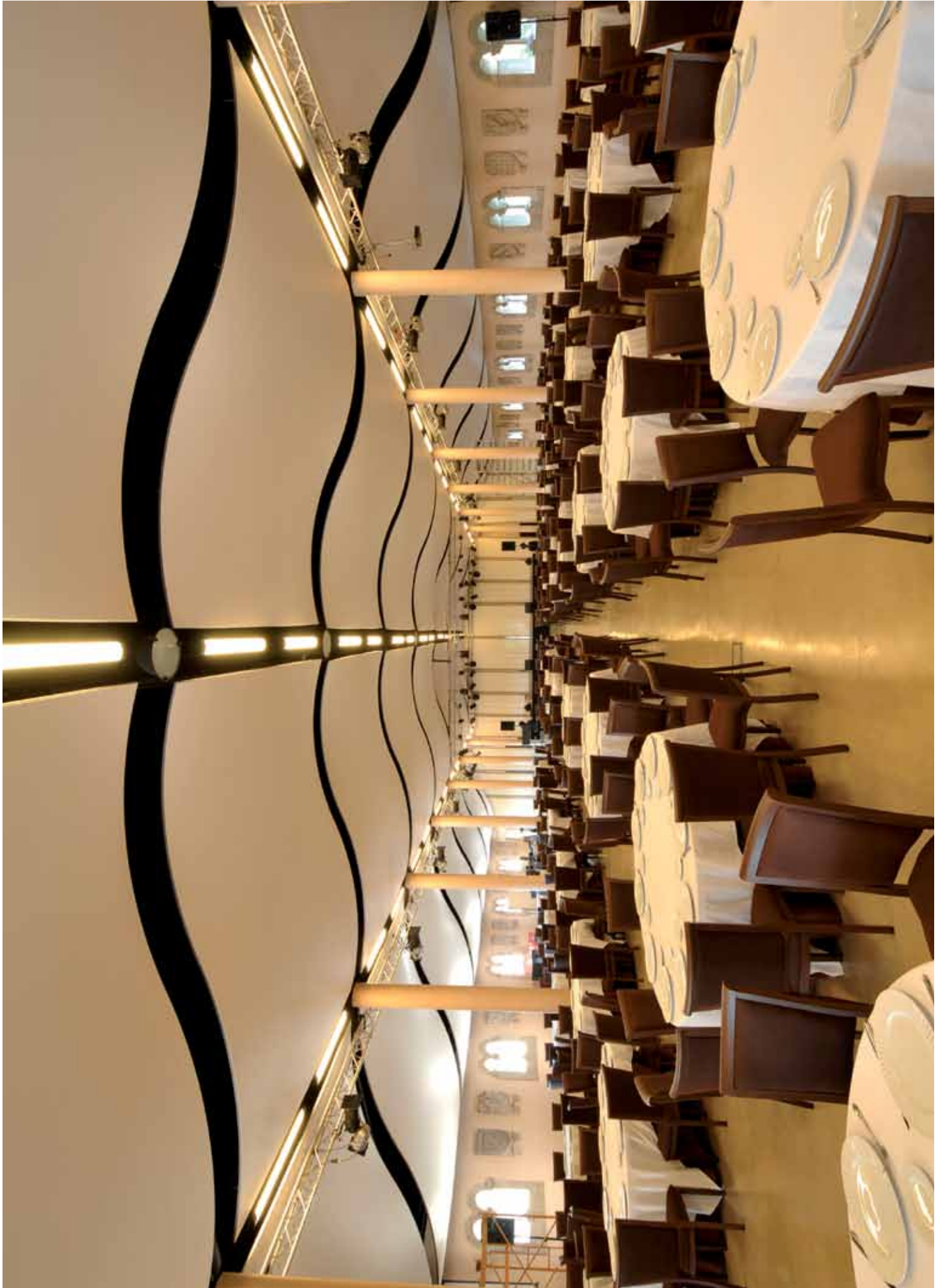



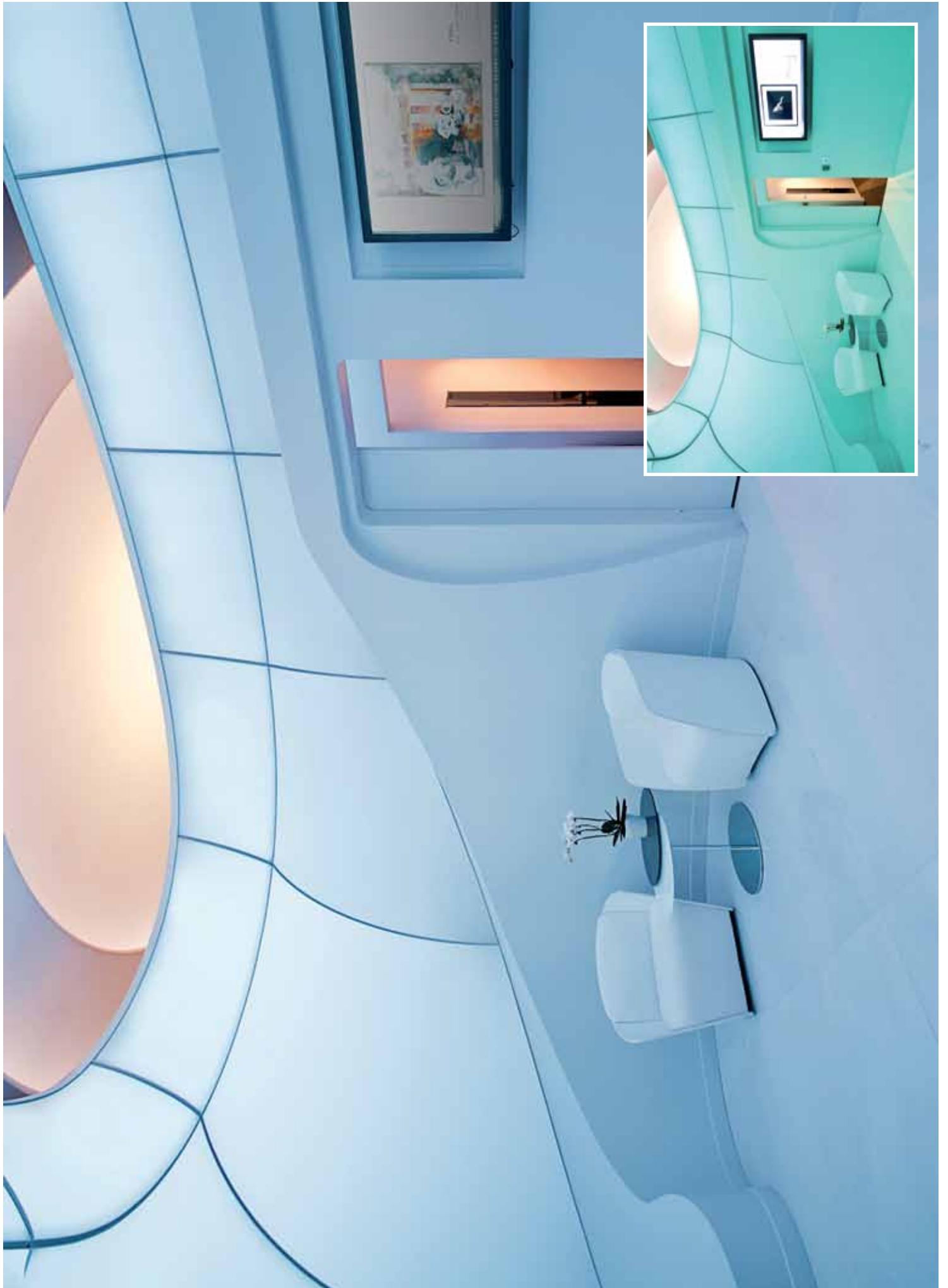





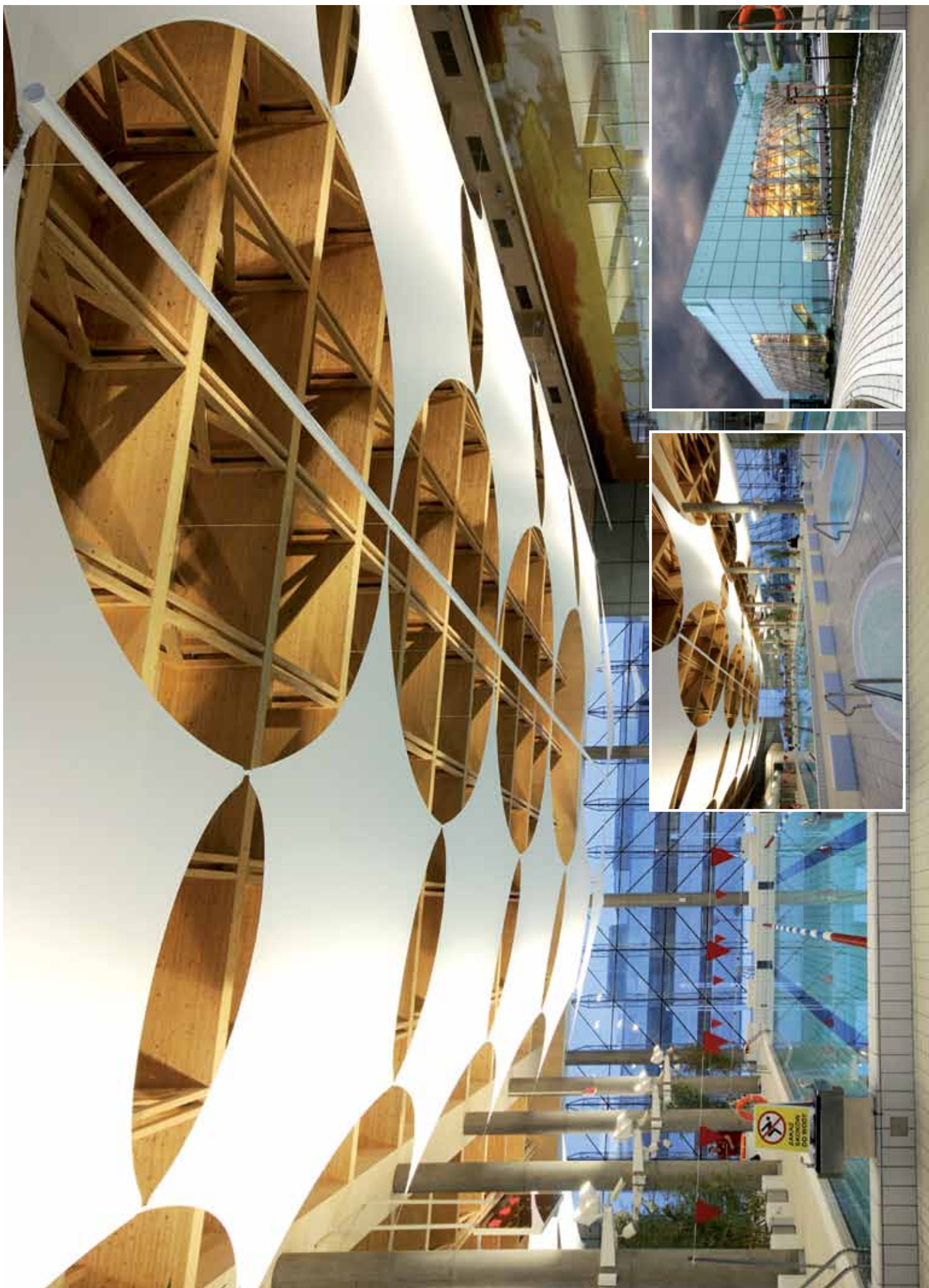

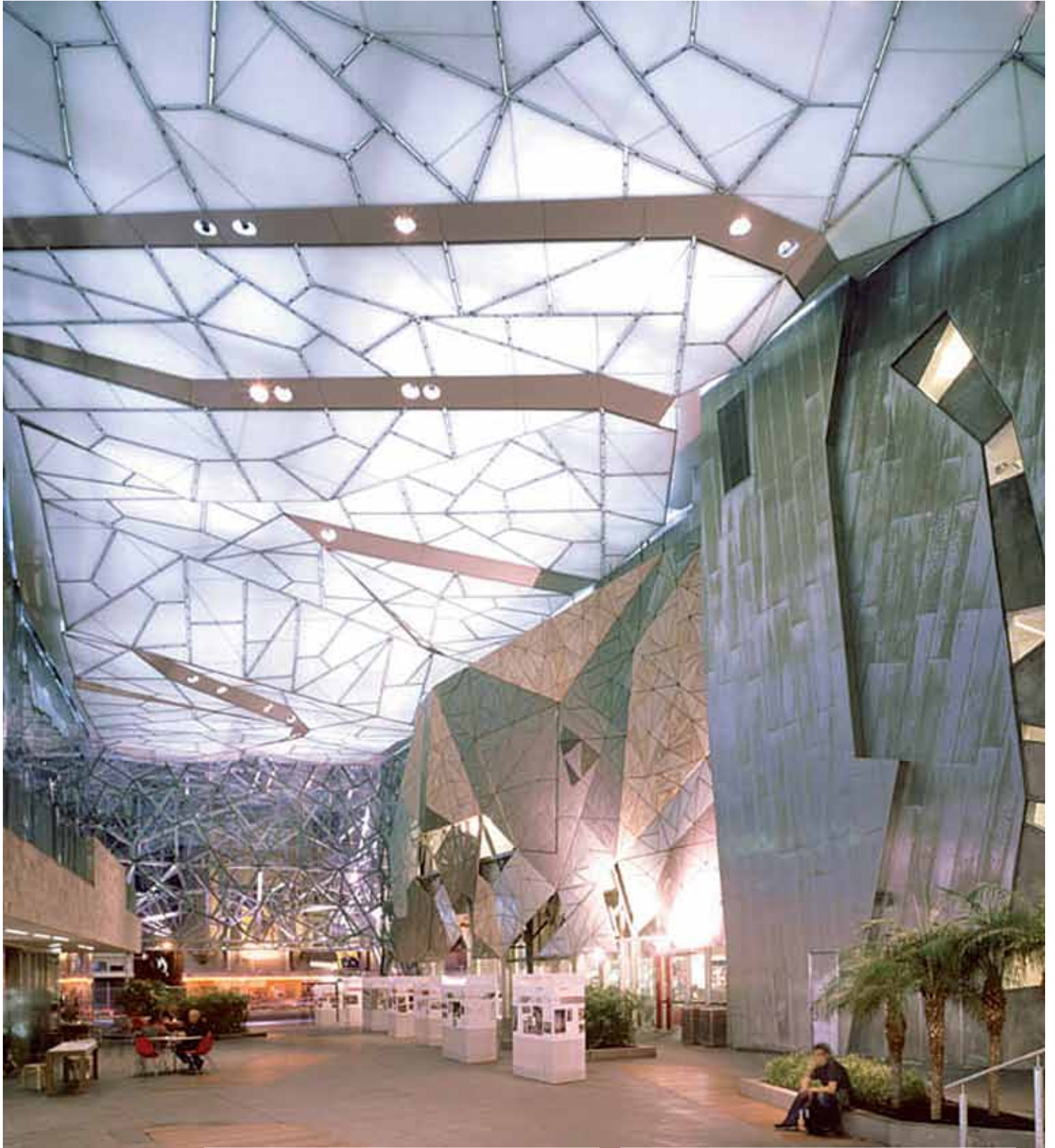

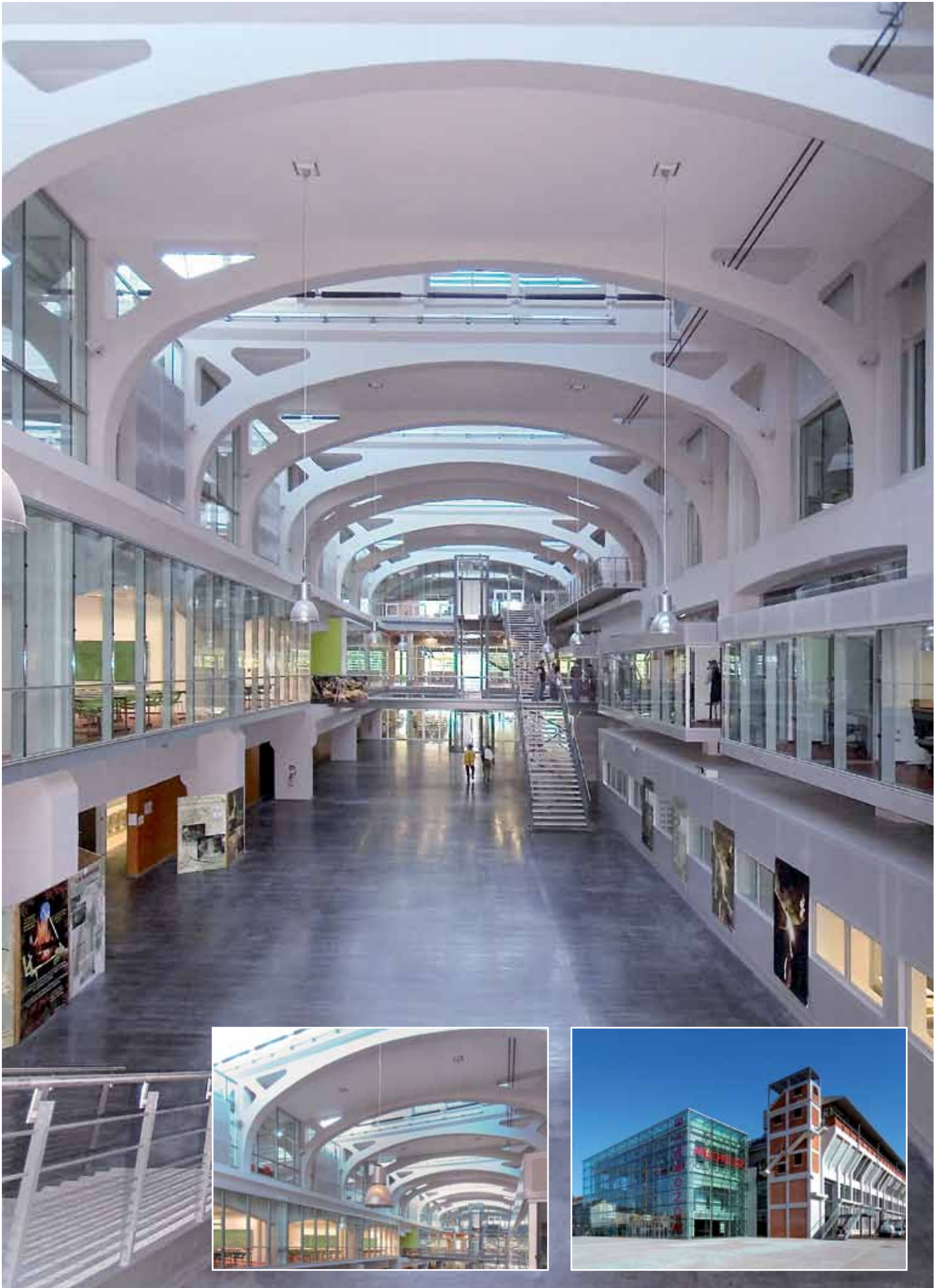

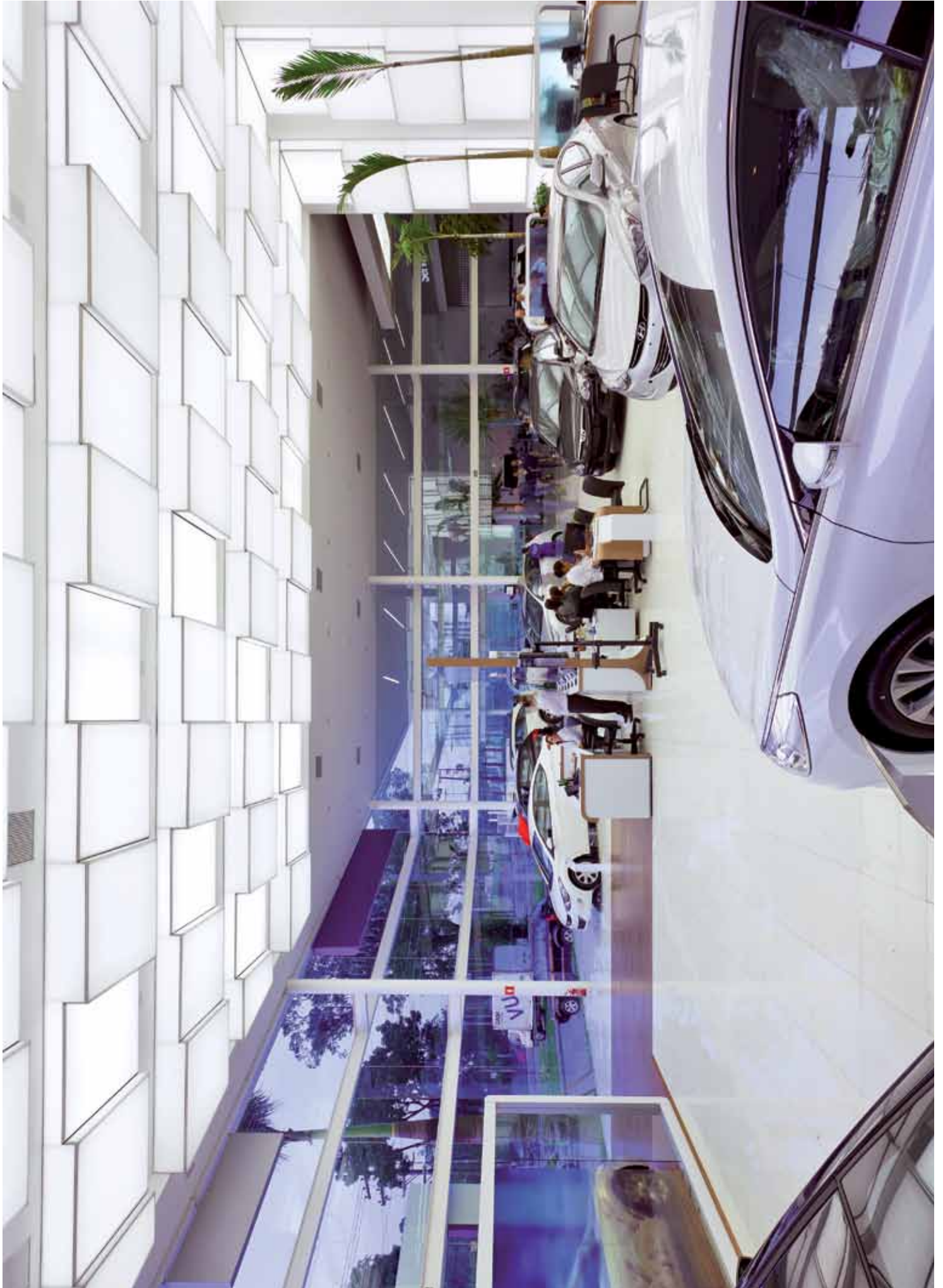

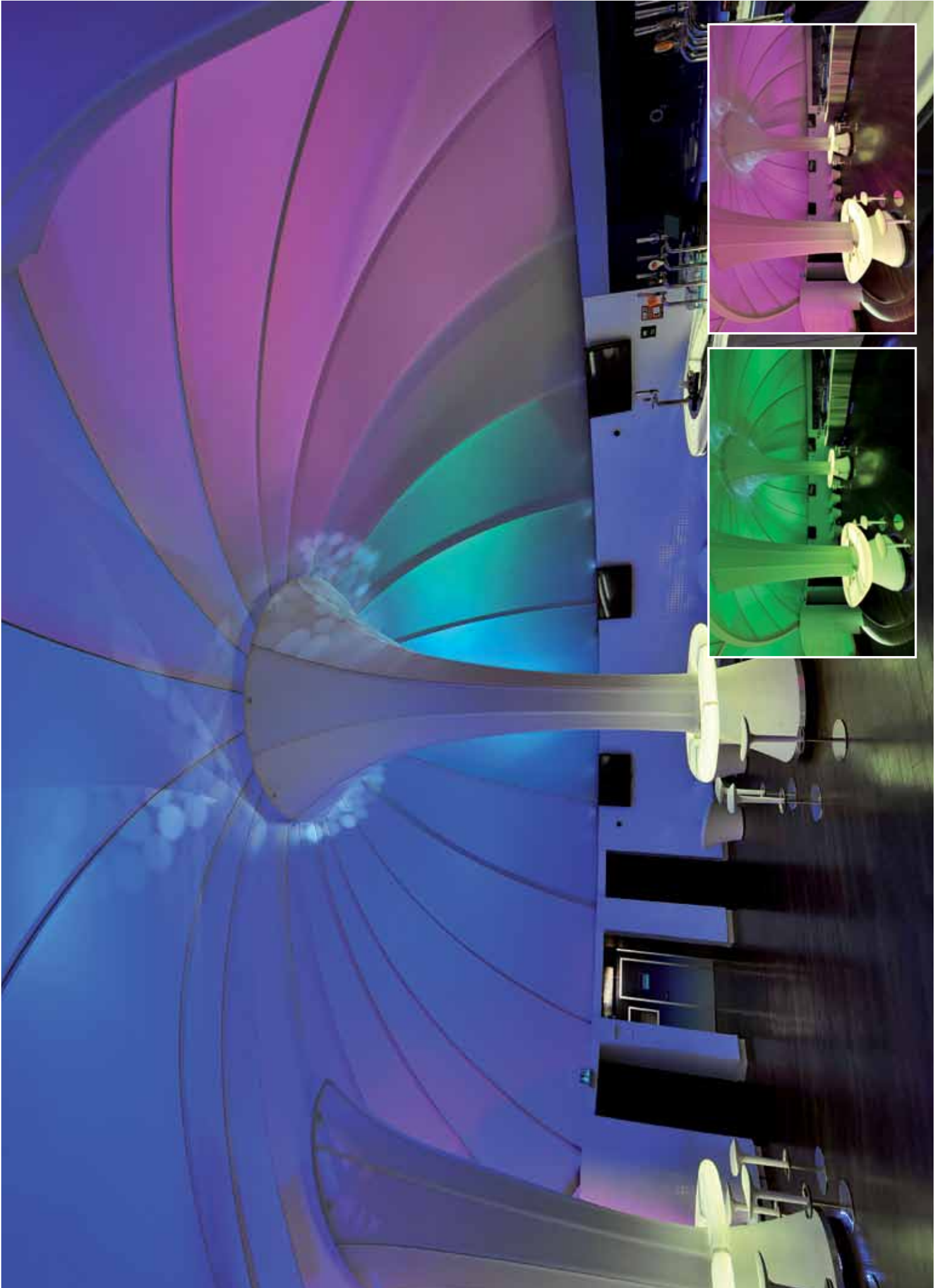

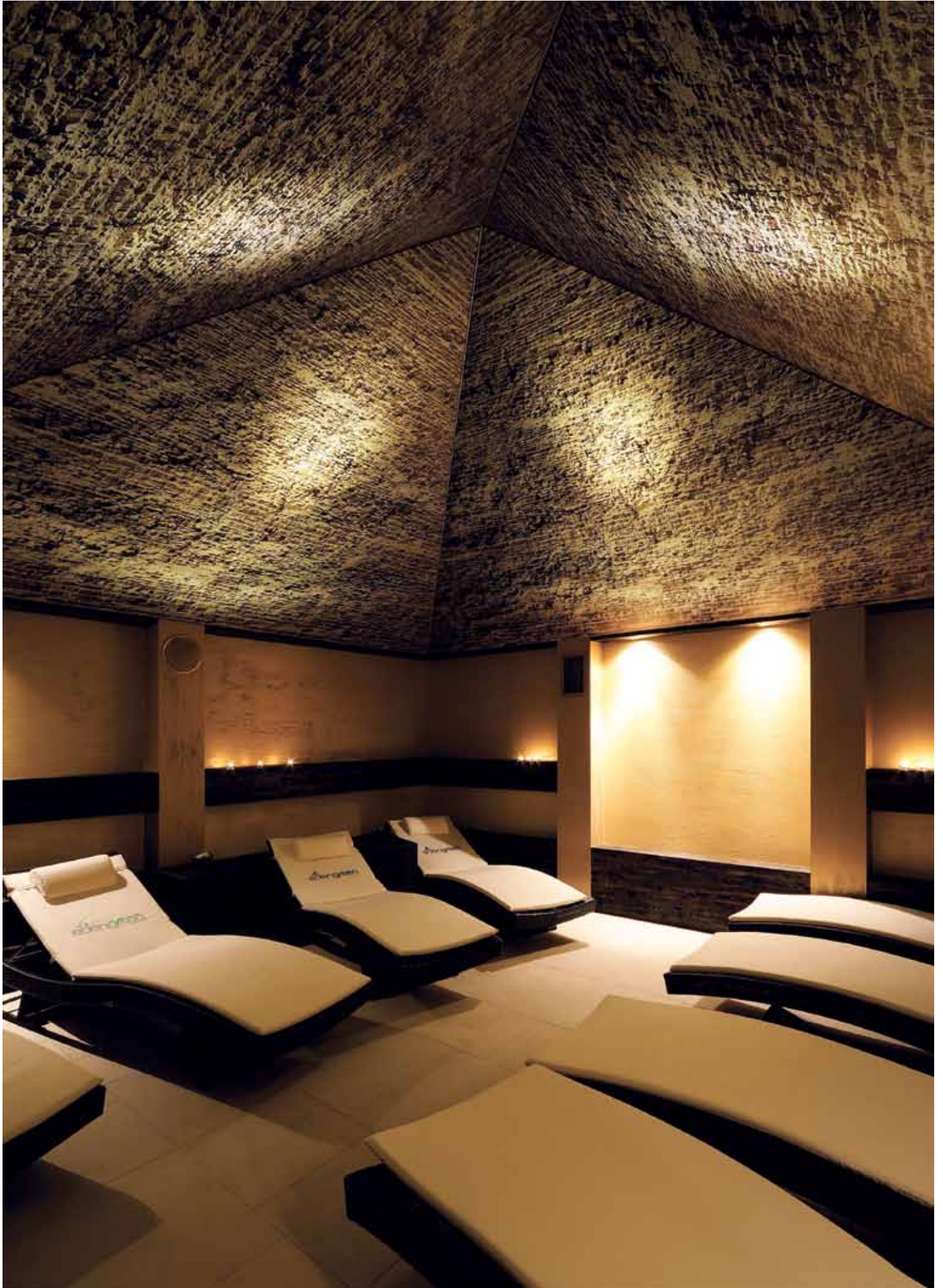





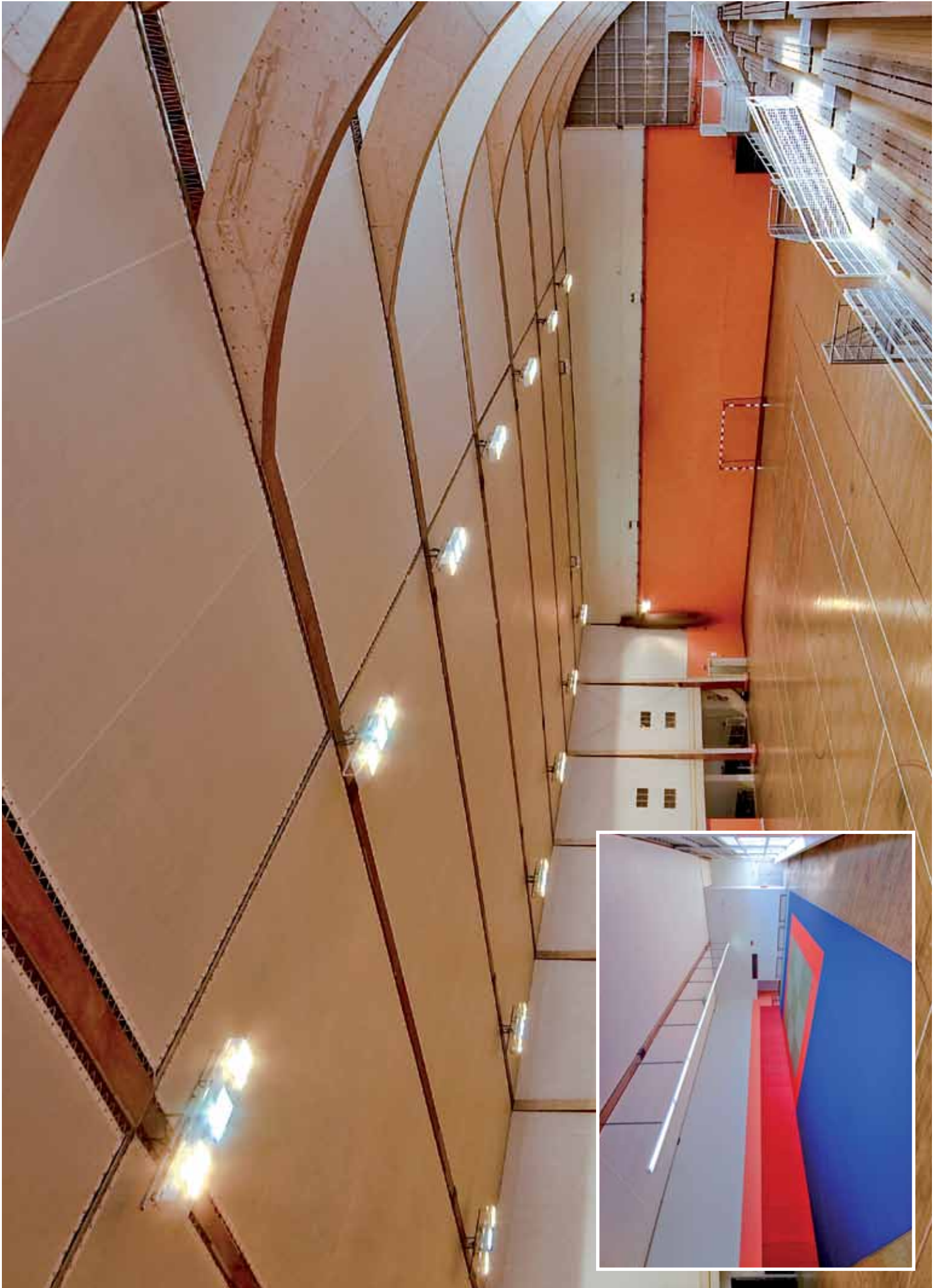





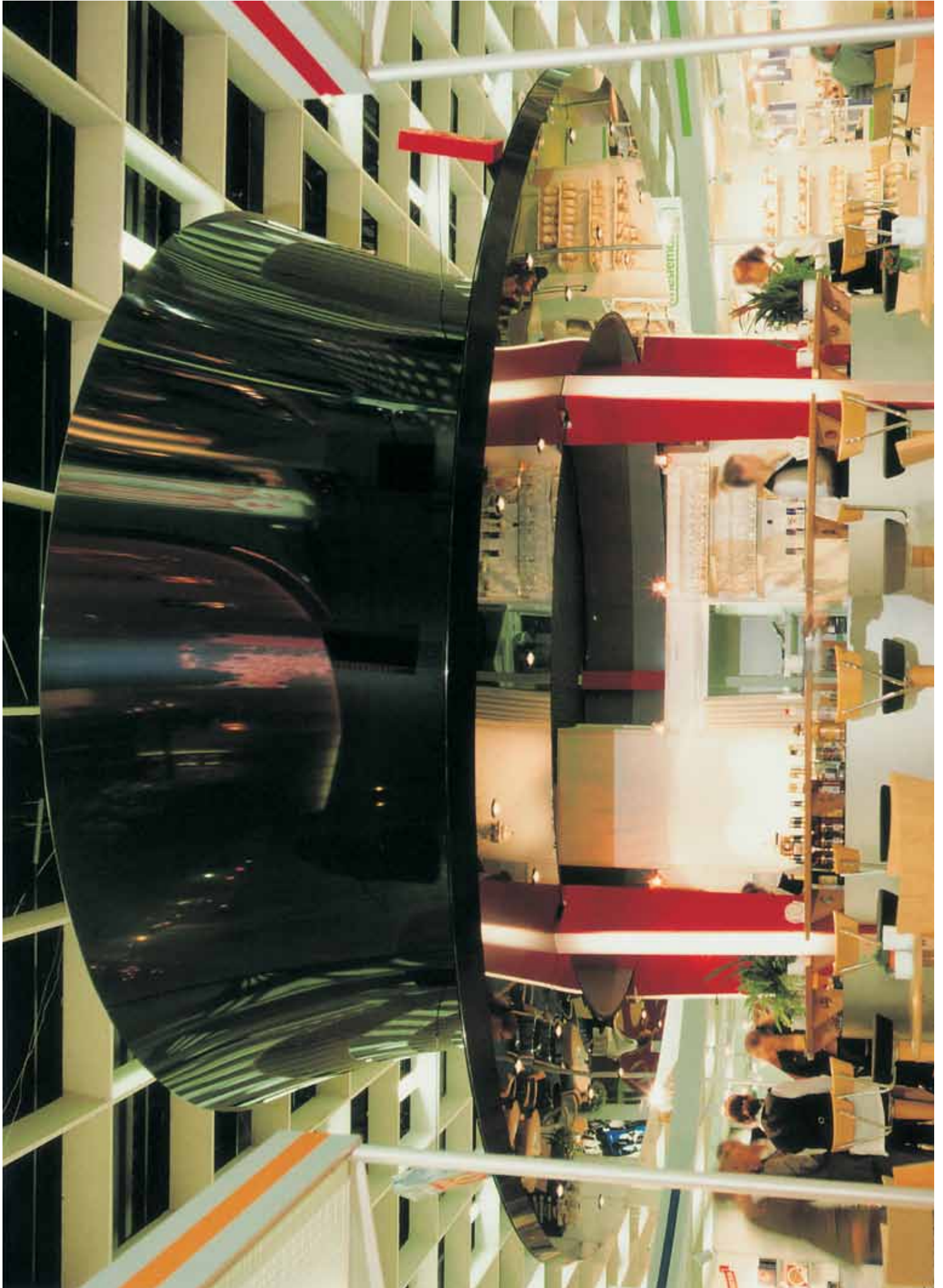



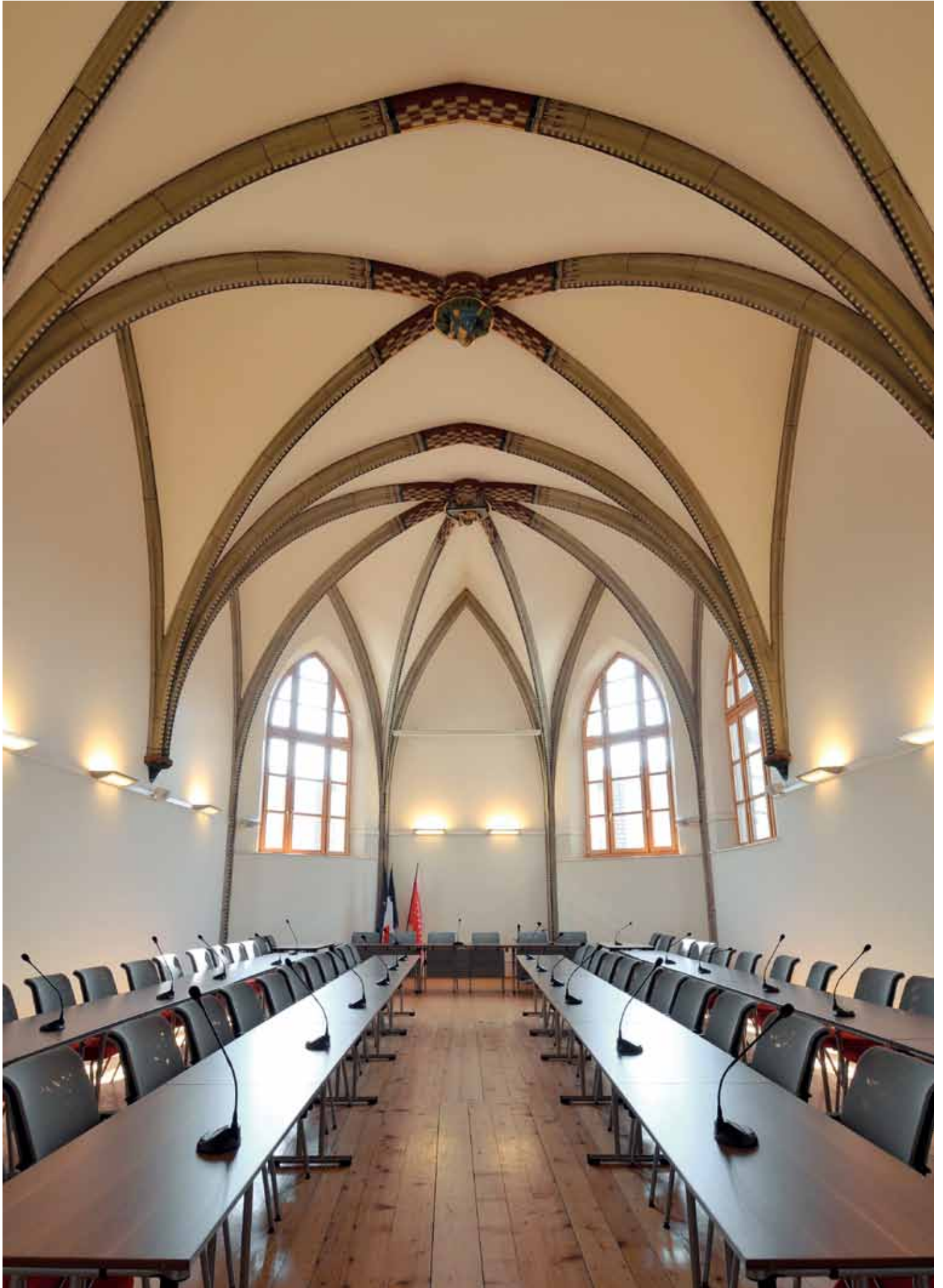

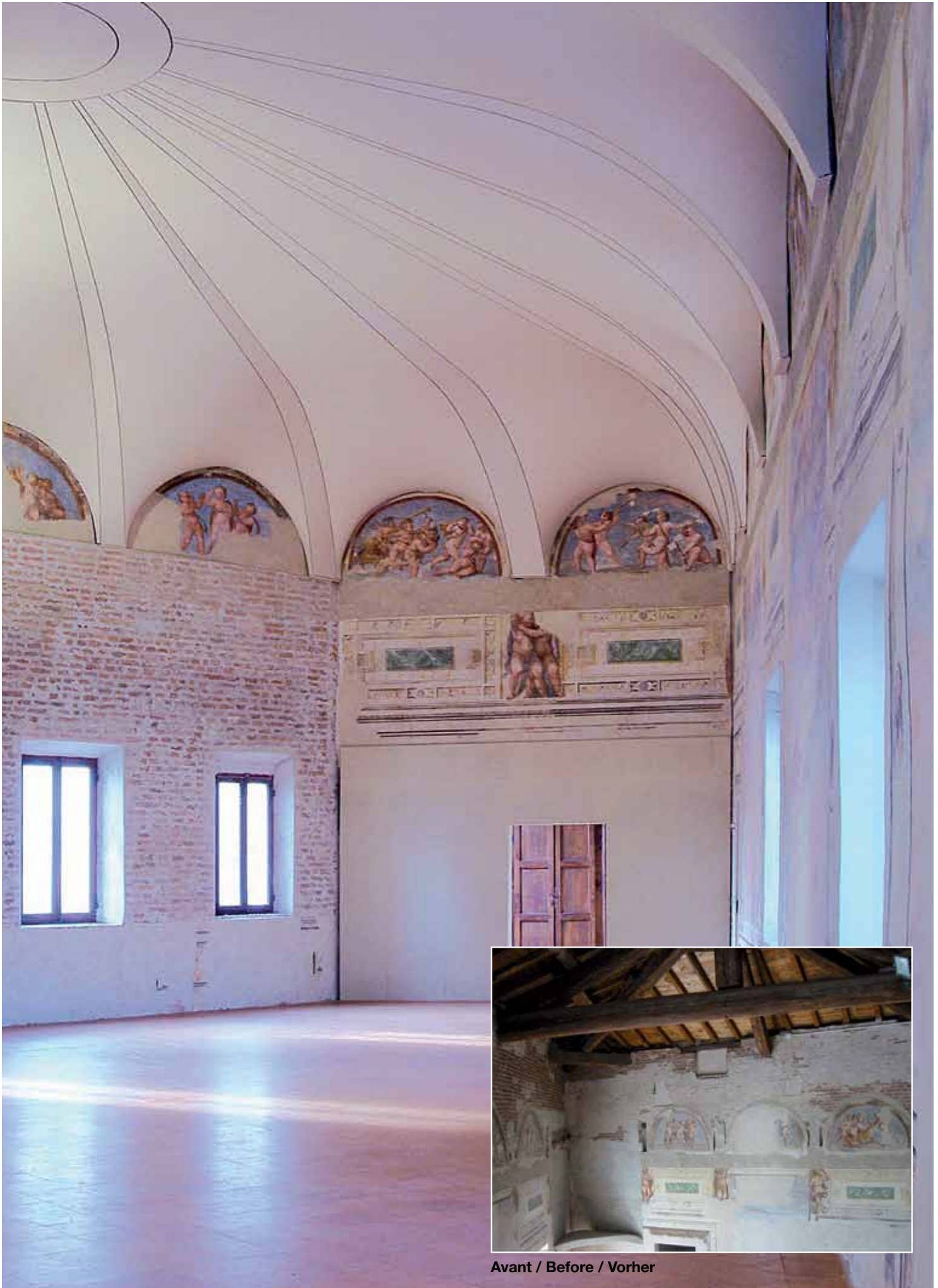

Avant / Before / Vorher









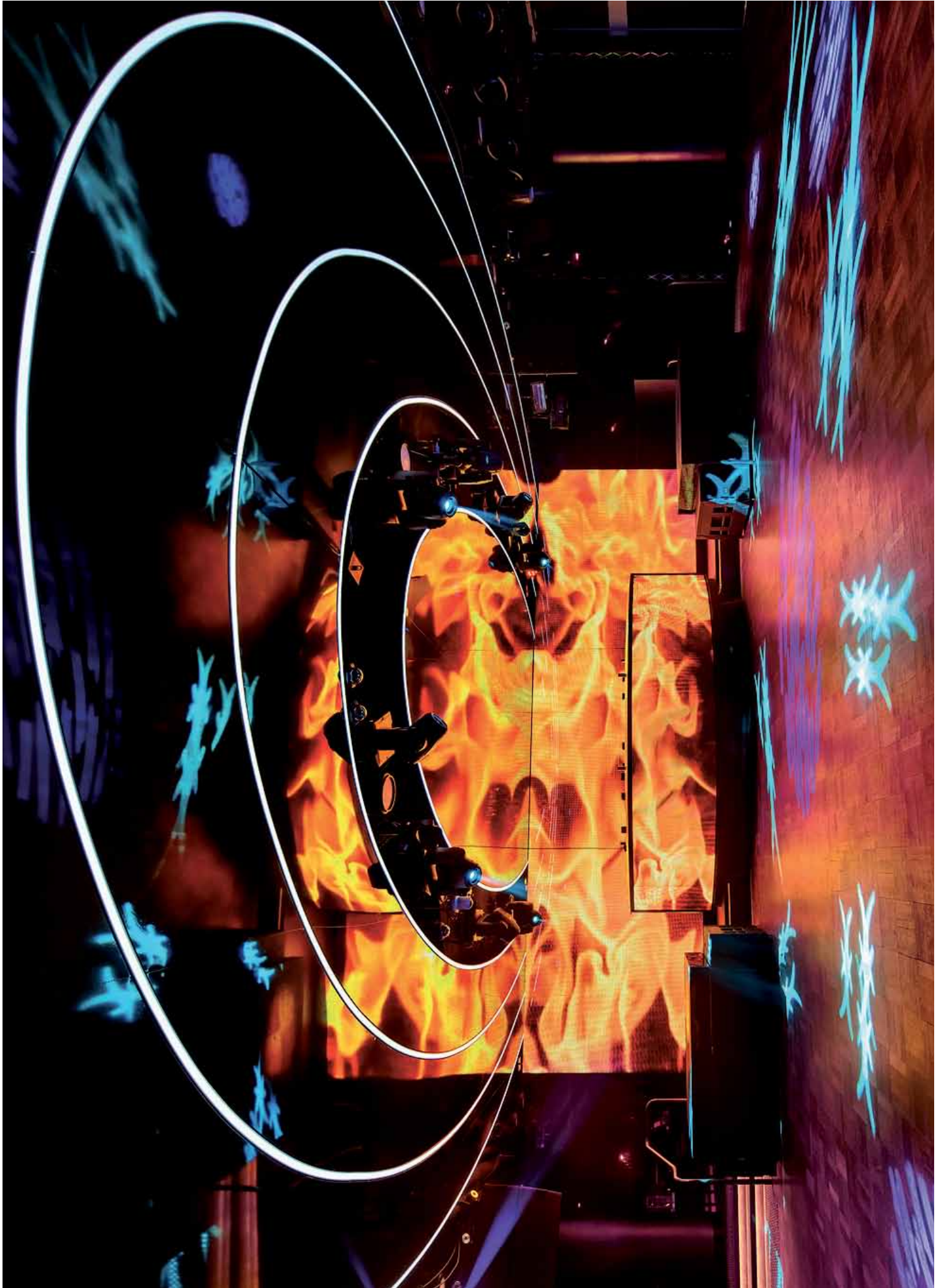



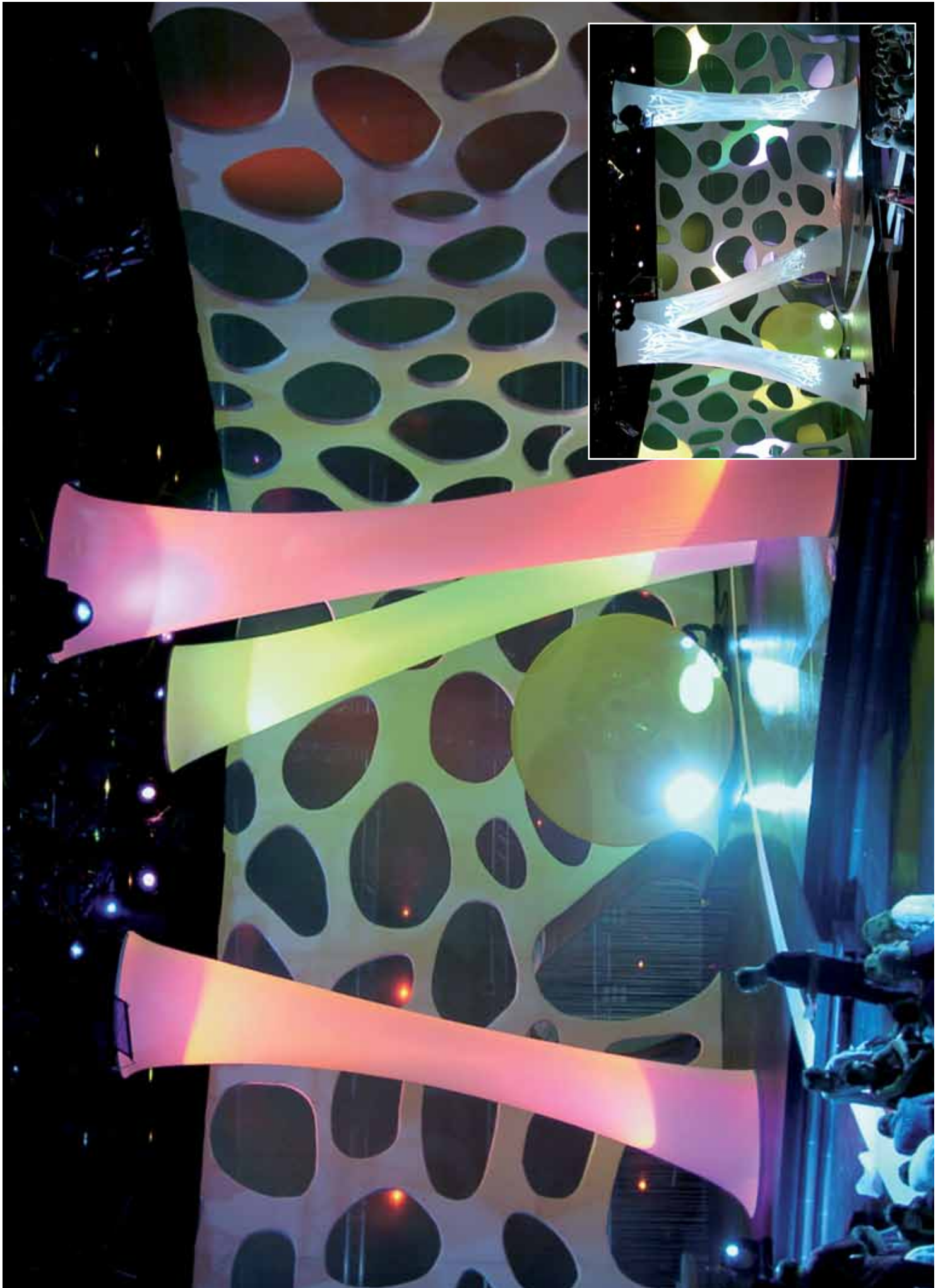

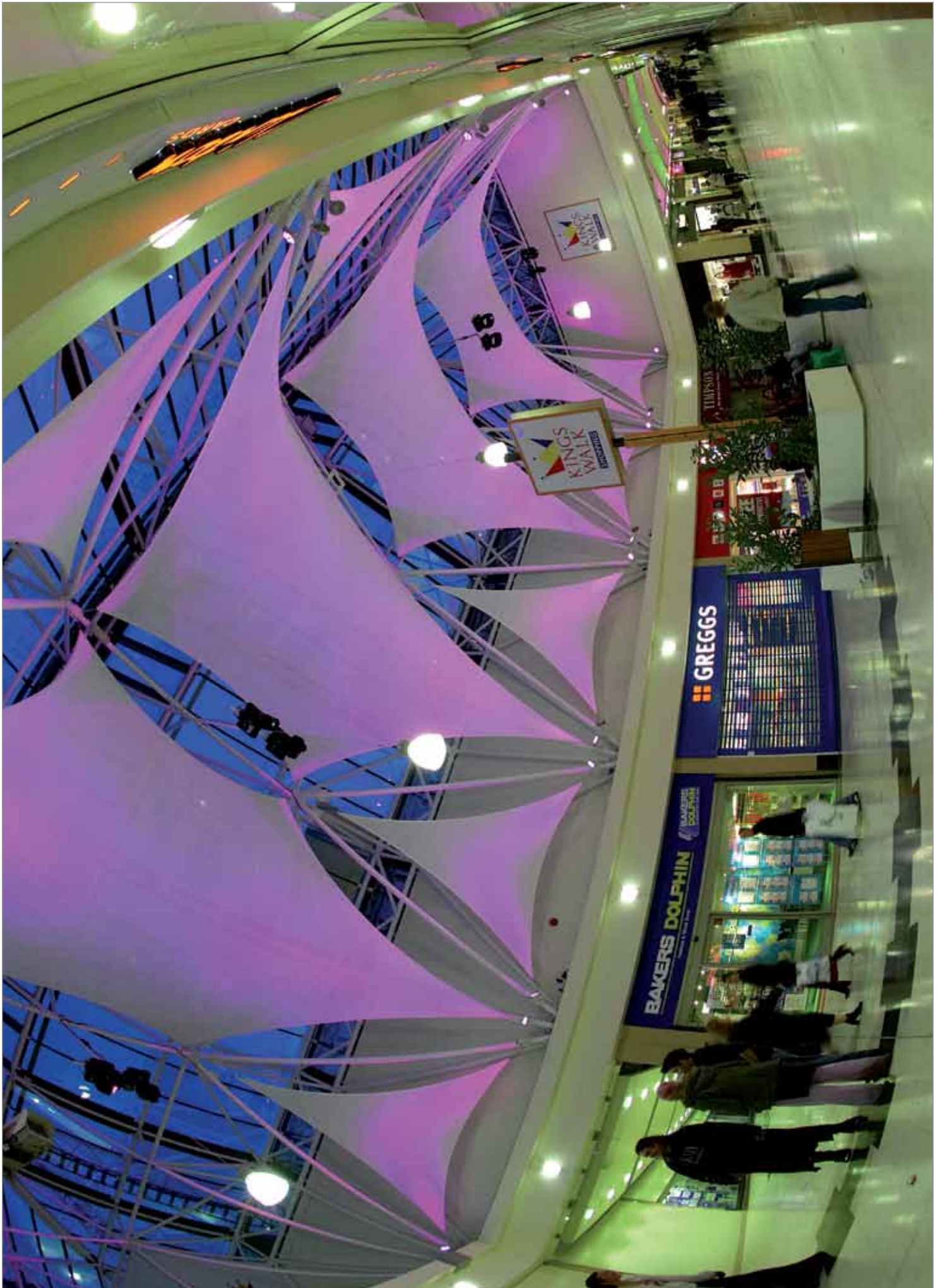





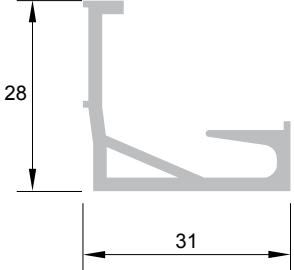

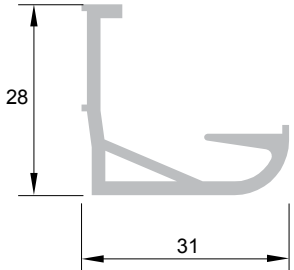
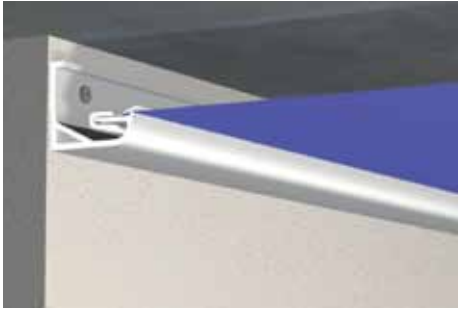
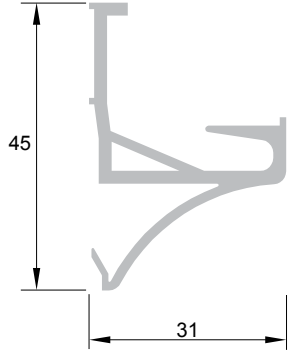

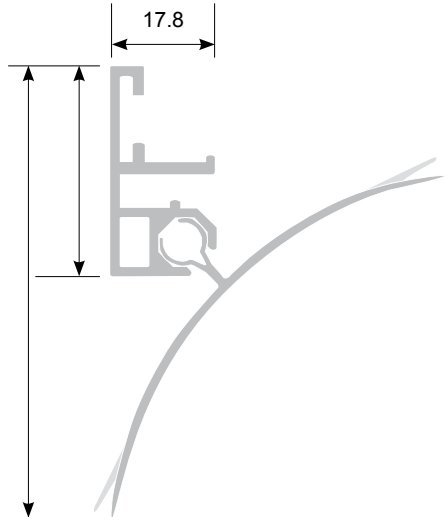
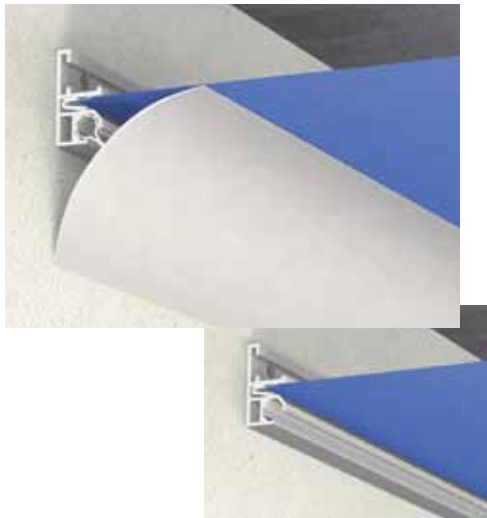



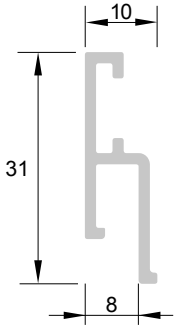

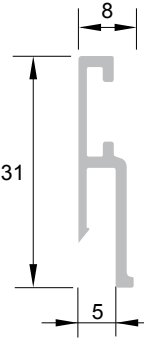
Profils & Eléments techniques

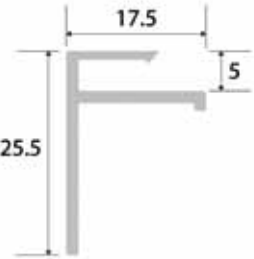
Rails systems - Leisten und Profile

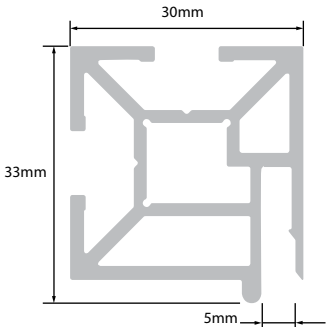
<p>Ref. : B 301</p> <p>Lisse PVC PVC track Kunststoffleiste</p> <p>poids - weight - Gewicht : 0.240 kg/ml</p>		
<p>Ref. : B 311</p> <p>Lisse PVC PVC track Kunststoffleiste</p> <p>poids - weight - Gewicht : 0.224 kg/ml</p>		
<p>Ref. : B 320</p> <p>Lisse PVC PVC track Kunststoffleiste</p> <p>poids - weight - Gewicht : 0.330 kg/ml</p>		
<p>Ref. : B 321/01</p> <p>Lisse PVC PVC track Kunststoffleiste</p> <p>poids - weight - Gewicht : 0.474 kg/ml + 0.203kg/ml</p>		

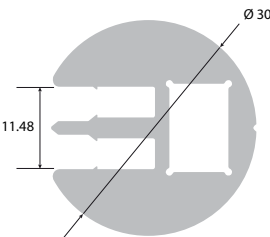
<p>Ref. : B 315</p> <p>Lisse aluminium Aluminium track Aluminium Leiste</p> <p>poids - weight - Gewicht : 0.757 kg/ml</p>		
<p>Ref. : B 316</p> <p>Lisse aluminium Aluminium track Aluminium Leiste</p> <p>poids - weight - Gewicht : 0.802 kg/ml</p>		
<p>Ref. : B 317</p> <p>Lisse aluminium Aluminium track Aluminium Leiste</p> <p>poids - weight - Gewicht : 1.039 kg/ml</p>		
<p>Ref. : B 318/01</p> <p>Lisse aluminium Aluminium track Aluminium Leiste</p> <p>poids - weight - Gewicht : 0.664 kg/ml</p>		
<p>Ref. : B318/011</p> <p>Lisse aluminium Aluminium track Aluminium Leiste</p> <p>poids - weight - Gewicht : 0.194 kg/ml</p>		
<p>Ref. : B 326/01</p> <p>Lisse aluminium Aluminium track Aluminium Leiste</p> <p>poids - weight - Gewicht : 0.260 kg/ml</p>		

<p>Ref. : B 350/01</p> <p>Lisse aluminium Aluminium track Aluminium Leiste</p> <p>poids - weight - Gewicht : 0.235 kg/ml</p>		
<p>Ref. : BMS 340/01 Ministar®</p> <p>Lisse aluminium Aluminium track Aluminium Leiste</p> <p>poids - weight - Gewicht : 0.207 kg/ml</p>		
<p>Ref. : BMS 340/11 Ministar®</p> <p>Lisse aluminium Aluminium track Aluminium Leiste</p> <p>poids - weight - Gewicht : 0.200 kg/ml</p>		
<p>Ref. : BMS 345/06 Ministar®</p> <p>Lisse aluminium Aluminium track Aluminium Leiste</p> <p>poids - weight - Gewicht : 0.859 kg/ml</p>		
<p>Ref. : BMS 345/20 Ministar®</p> <p>Lisse aluminium Aluminium track Aluminium Leiste</p> <p>poids - weight - Gewicht : 1.241 kg/ml</p>		

<p>Ref. : BS 350/02</p> <p>Séparateur aluminium Aluminium separator Aluminium Trennprofil</p> <p>poids - weight - Gewicht : 0.537 kg/ml</p>		
<p>Ref. : BS 350/03</p> <p>Séparateur d'angle aluminium Aluminium separator for corner Aluminium Trennprofil für Außenwinkel</p> <p>poids - weight - Gewicht : 0.431 kg/ml</p>		
<p>Ref. : BS 350/04</p> <p>Lisse aluminium Aluminium track Aluminium Leistel</p> <p>poids - weight - Gewicht : 0.294 kg/ml</p>		
<p>Ref. : BS 350/05</p> <p>Lisse aluminium avec cimaise Aluminium track with suspension Aluminium Leiste mit Abhängevorrichtung</p> <p>poids - weight - Gewicht : 0.360 kg/ml</p>		
<p>Réf. : BS 350/06</p> <p>Lisse aluminium Aluminium track Aluminium Leiste</p> <p>poids - weight - Gewicht : 0.274 kg/ml</p>		
<p>Réf. : BS 350/11</p> <p>Lisse aluminium murale Aluminium wall track Aluminium Leiste</p> <p>poids - weight - Gewicht : 0.241kg/ml</p>		

Réf. : BS 350/15

Lisse aluminium murale d'angle
Aluminium wall rail for angles
Aluminium Wandleiste gewinkelt

poids - weight - Gewicht :
0.496kg/ml

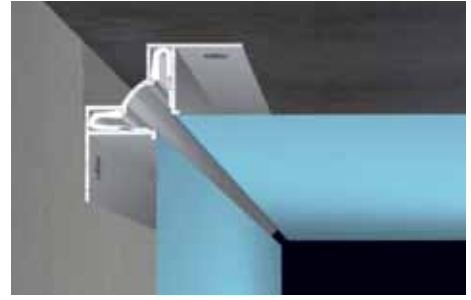
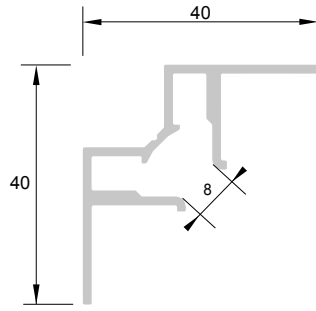

Réf. : BS 350/16

Séparateur aluminium
Aluminium separator
Aluminium Trennprofil

poids - weight - Gewicht :
0.432 kg/ml

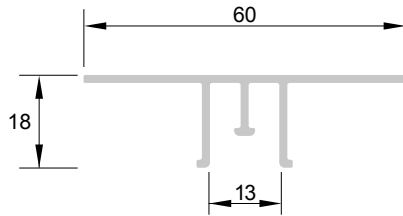

Réf. : BS 350/18

Séparateur aluminium pour cloisons et
sprinklers
Aluminium separator for partitions and
sprinklers
Aluminium Trennprofil für Trennwände und
spinklers

poids - weight - Gewicht :
1.037 kg/ml

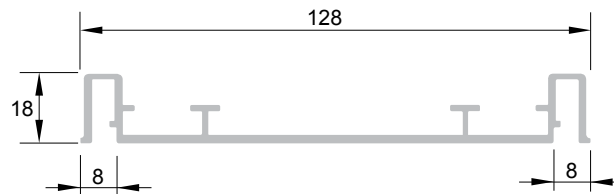

Réf. : BS 350/19

Séparateur aluminium en joint creux
pour cloisons et sprinklers
Aluminium separator for partitions and
sprinklers
Aluminium Trennprofil mit
Schattenfuge für Trennwände und
spinklers

poids - weight - Gewicht :
1.286 kg/ml

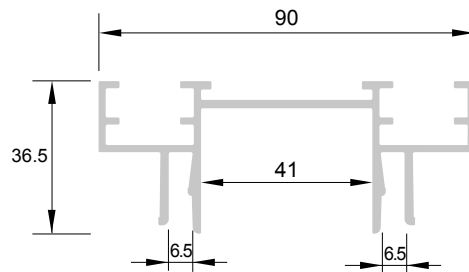

Réf. : BS 350/20

BS 350/201
BS 350/202

Séparateur aluminium
Aluminium separator
Aluminium Trennprofil

poids - weight - Gewicht :
0.837 kg/ml

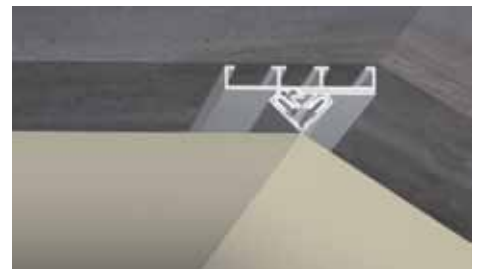
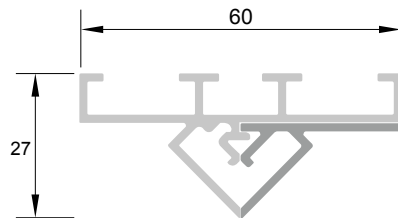

Réf. : BS 350/21

Séparateur aluminium 6mm
Aluminium separator 6mm
Aluminium Trennprofil 6mm

poids - weight - Gewicht :
0.483kg/ml

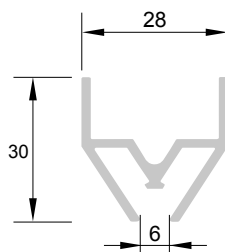

<p>Réf. : BS 350/22</p> <p>Séparateur aluminium Aluminium separator Aluminium Trennprofil</p> <p>poids - weight - Gewicht : 1.011 kg/ml</p>		
<p>Réf. : BS 350/23</p> <p>Séparateur aluminium Aluminium separator Aluminium Trennprofil</p> <p>poids - weight - Gewicht : 0.472 kg/ml</p>		
<p>Réf. : BS 350/61 2 directions - 2 directions - 2 Richtungen</p> <p>Réf. : BS 350/62 4 directions - 4 directions - 4 Richtungen</p> <p>Lisse aluminium Aluminium track Aluminium Leiste</p> <p>poids - weight - Gewicht : 0.212 kg/ml</p>		
<p>Réf. : BS 350/66</p> <p>Séparateur aluminium Aluminium separator Aluminium Trennprofil</p> <p>poids - weight - Gewicht : 0.346 kg/ml</p>		
<p>Réf. : BS 350/165</p> <p>Séparateur aluminium Aluminium separator Aluminium Trennprofil</p> <p>poids - weight - Gewicht : 1.123kg/ml</p>		

Réf. : BS 355/02

Lisse aluminium pour cadre modulaire
Aluminium track for modular frames
Aluminium Profil für Modulrahmen

poids - weight - Gewicht :
1.130 kg/ml

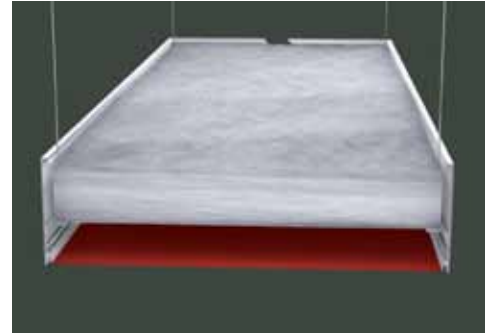
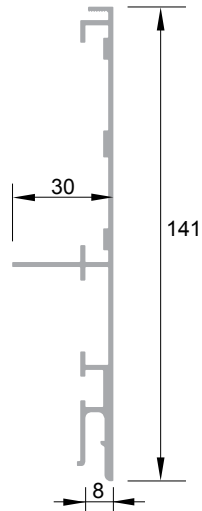

Réf. : BS 355/04

Lisse aluminium pour cadre modulaire
Aluminium track for modular frames
Aluminium Profil für Modulrahmen

poids - weight - Gewicht :
1.074 kg/ml

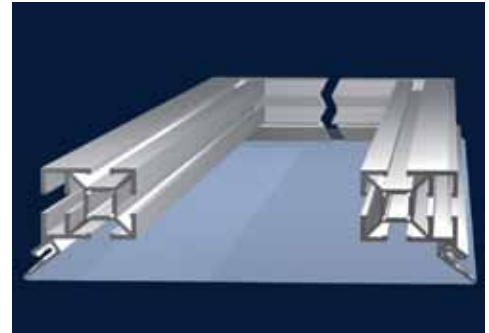
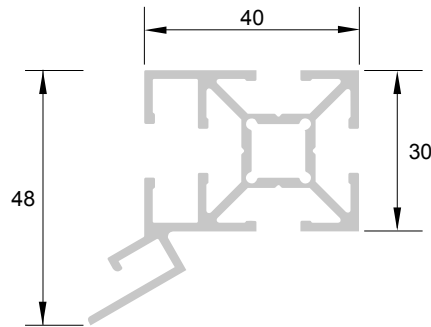

Réf. : BS 355/05

Système pour cadre modulaire
System for modular frames
Rahmenprofil System

poids - weight - Gewicht :
0.806kg/ml

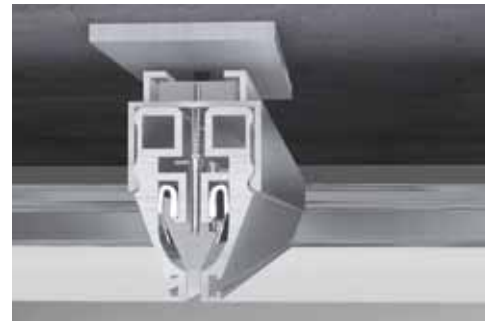
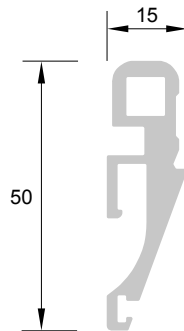

Réf. : BS 355/06

Profil aluminium pour cadre modulaire
Aluminium profile for modular frames
Rahmenprofil

poids - weight - Gewicht :
0.861 kg/ml

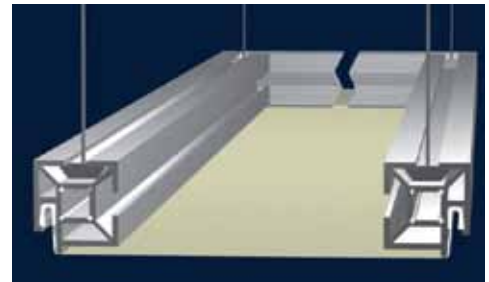
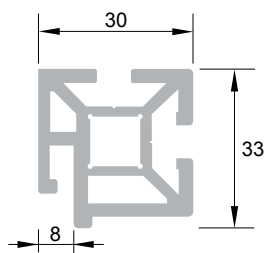

Réf. : BS 355/08

Profil aluminium pour cadre
modulaire double toile
Aluminium profile for double
sheet modular frames
Rahmenprofil doppelagig

poids - weight - Gewicht :
1.120 kg/ml

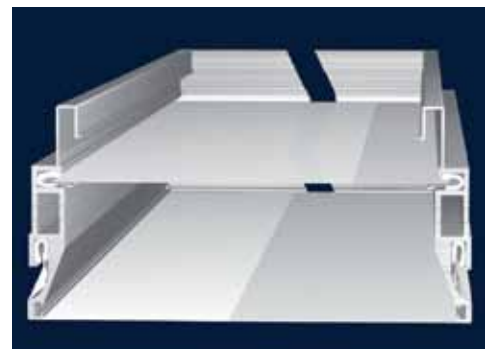
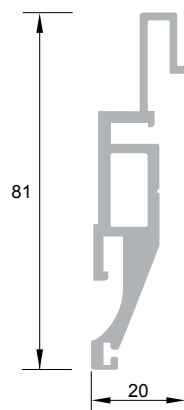

<p>Réf. : BS 350/10</p> <p>Profil aluminium mural double toile Double sheet wall aluminium profile Aluminium doppellagig Wandleiste</p> <p>poids - weight - Gewicht : 0.528 kg/ml</p>		
<p>Réf. : BS 355/14</p> <p>Profil aluminium pour cadre modulaire double toile Aluminium profile for double sheet modular frames Aluminium Rahmenprofil doppellagig</p> <p>poids - weight - Gewicht : 1.083 kg/ml</p>		
<p>Réf. : BS 355/15</p> <p>Profil aluminium pour cadre modulaire double toile Aluminium profile for double sheet modular frames Aluminium doppellagig Rahmenprofil</p> <p>poids - weight - Gewicht : 1.244 kg/ml</p>		
<p>Réf. : BS 355/17</p> <p>Profil aluminium pour cadre modulaire luminiun profile for modular frames Aluminium Rahmenprofil</p> <p>poids - weight - Gewicht : 1.161 kg/ml</p>		
<p>Réf. : BS 355/18</p> <p>Profil aluminium pour cadre modulaire luminiun profile for modular frames Aluminium Rahmenprofil</p> <p>poids - weight - Gewicht : 1.150 kg/ml</p>		

Réf. : BS 355/25

Profil aluminium pour cadre modulaire double toile
 Aluminium profile for double sheet modular frames
 Aluminium doppelagig Rahmenprofil

poids - weight - Gewicht :
 1.609 kg/ml

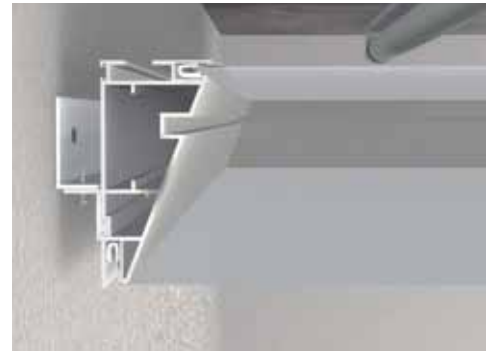
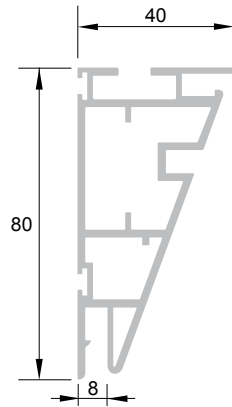

Réf. : BS 355 / 35

Profil aluminium pour cadre modulaire double toile
 Aluminium profile for double sheet modular frames
 Aluminium doppelagig Rahmenprofil

poids - weight - Gewicht :
 1.555 kg/ml

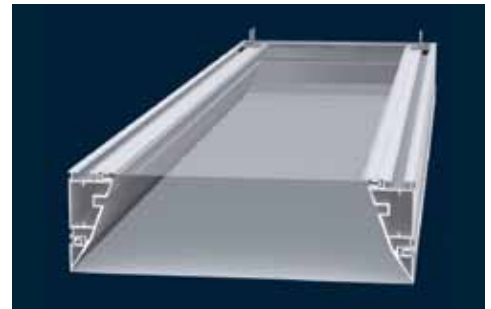
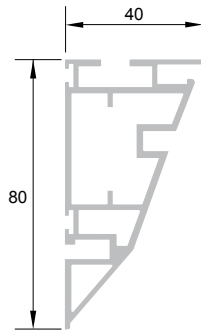

Réf. : BS 355 / 45

Profil aluminium pour cadre modulaire double toile
 Aluminium profile for double sheet modular frames
 Aluminium doppelagig Rahmenprofil

poids - weight - Gewicht :
 0.799 kg/ml

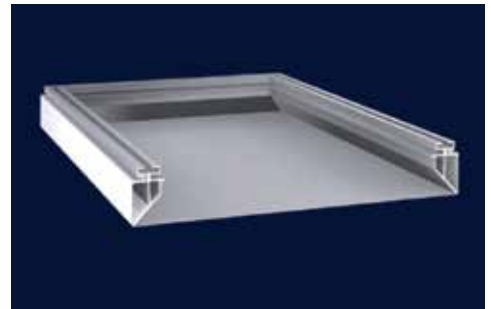
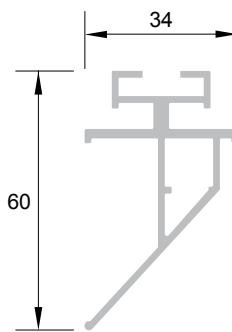

Réf. : BS 355 / 55

Profil aluminium pour cadre modulaire
 Aluminium profile for modular frames
 Aluminium Rahmenprofil

poids - weight - Gewicht :
 1.428 kg/ml

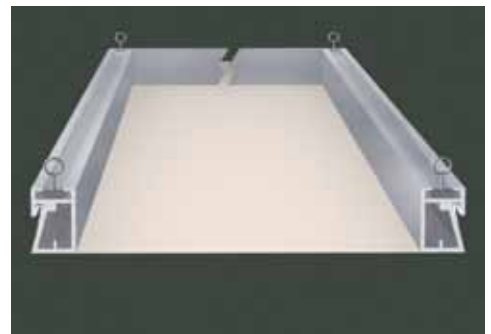
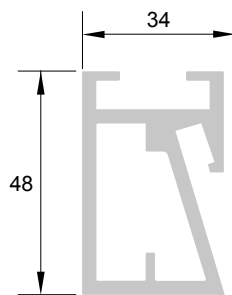

Réf. : BS 355/163

Profil aluminium pour cadre modulaire double toile
 Aluminium profile for double sheet modular frames
 Aluminium doppelagig Rahmenprofil

poids - weight - Gewicht :
 1.025kg/ml

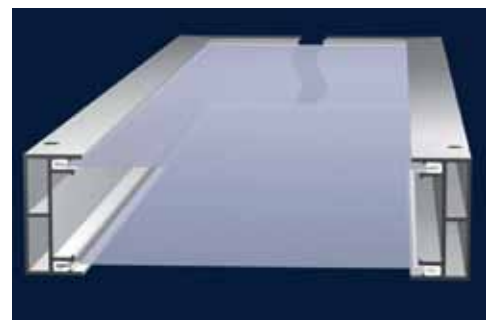
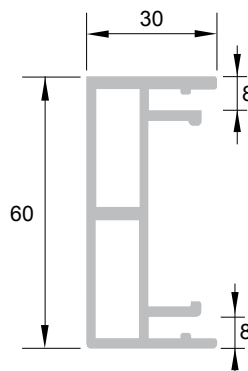

Réf. : BS 365 / 20

Tube aluminium double enclenchement
Aluminium double sheet tube
Aluminium Röhrenprofil für doppelfolie

poids - weight - Gewicht :
1.470 kg/ml

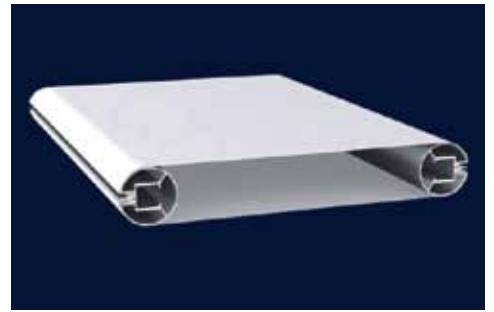
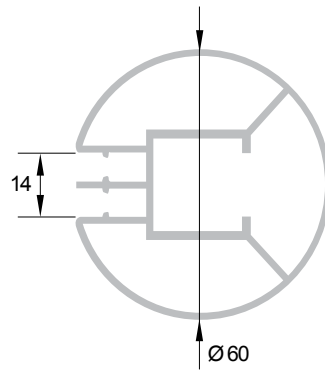

Réf. : BS 365 / 30

Tube aluminium tridirectionnel
Aluminium tridirectionnal tube
Aluminium tridirectionnel Röhre

poids - weight - Gewicht :
1.662 kg/ml

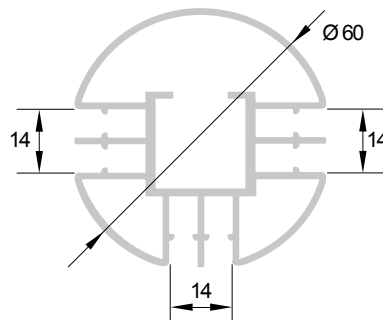

Trempo®
Réf. : BT 310
Sandows

Profil aluminium Trempo®
Aluminium Trempo® profile
Aluminium Trempo® Profil

poids - weight - Gewicht :
0.243 kg/ml

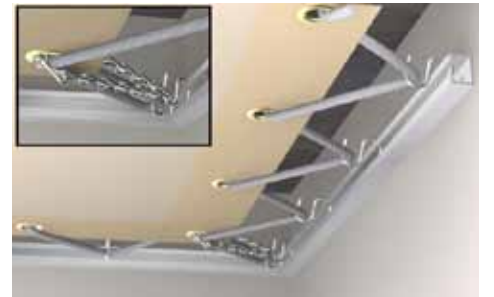
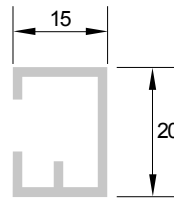

Trempo®
Réf. : BT 320
ressorts - spring - Feder

Profil aluminium Trempo®
Aluminium Trempo® profile
Aluminium Trempo® Profil

poids - weight - Gewicht :
0.437 kg/ml

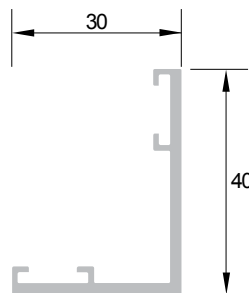

Trempo®
platine - plate - Platte

Profil Trempo fixation platines
Trempo with plate fixation
Trempo Befestigung durch Platte

Différents modèles de fixation platine disponibles.
Different types of plate fixations available.
Verschiedene Befestigungselemente laut der Projekt zu realisieren.



COPYRIGHT © 2009 - 2012 BARRISOL NORMALU S.A.S. - Tous droits réservés.

La reproduction totale ou partielle de ce document est interdite, son traitement informatique, sa transmission sous quelque forme que ce soit, par moyen électronique, mécanique, par photocopie, par enregistrement ou autres méthodes sont interdits.

The total or partial reproduction of this document is prohibited, its data-processing treatment, its transmission in some form or average electronic, mechanical, by photocopy, recording or other methods are prohibited.

Die volle oder teilweise Reproduktion dieses Dokument ist verboten, sein Informationsgehalt, seine Übertragung in irgendeine andere Form, elektronisch, mechanisch durch Photokopie, durch Erfassung oder andere Methoden sind verboten.



BARRISOL®

Photos 2 / 2012-2013



BARRISOL NORMALU SAS

Route du Sipes 68680 Kembs - France

Tél. : +33 (0)3 89 83 20 20

Fax : +33 (0)3 89 48 43 44

E-mail : mail@barrisol.com

www.barrisol.com



CERTIFIÉ PAR UN LABORATOIRE INDÉPENDANT
CERTIFIED BY AN INDEPENDENT LABORATORY
VON EINEM UNABHÄNGIGEN LABOR BESTÄTIGT
(LNE)

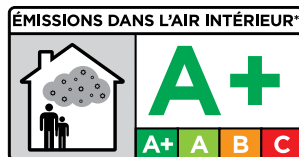

* Information sur le niveau d'émission de substances volatiles dans l'air intérieur, présentant un risque de toxicité par inhalation, sur une échelle de classe allant de A+ (très faibles émissions) à C (fortes émissions)

Information on the emission level of volatile substances indoors, based on the risk of toxicity due to inhalation, on a scale ranging from Class A+ (very low emissions) to C (high emissions)
Informationen über das Emissionsniveau von flüchtigen Substanzen in der Luft von Innenräumen, die ein Gesundheitsrisiko beim Atmen darstellen, aufgelistet in einer Klassifikation von A+ (sehr schwache Emission) bis Klasse C (hohe Emission).

